

CWC 1000 V2

Compact Height

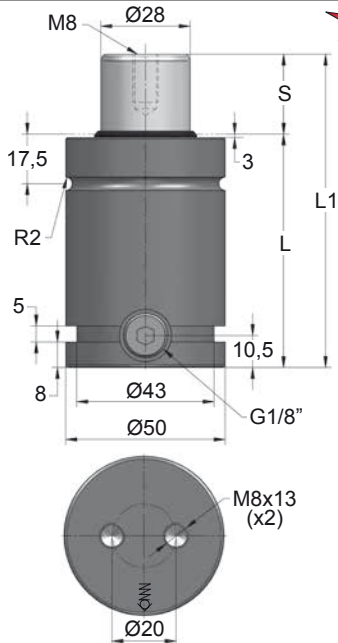



ORDER	S (mm)	L1 ±0,25 (mm)	L (mm)	Kg.
CWC 1000 013 V2	13	74	61	0.73
CWC 1000 016 V2	16	80	64	0.75
CWC 1000 019 V2	19	86	67	0.78
CWC 1000 025 V2	25	98	73	0.83
CWC 1000 032 V2	32	112	80	0.89
CWC 1000 038 V2	38	124	86	0.94
CWC 1000 050 V2	50	148	98	1.04
CWC 1000 063 V2	63	174	111	1.15
CWC 1000 075 V2	75	198	123	1.25
CWC 1000 080 V2	80	208	128	1.29
CWC 1000 100 V2	100	248	148	1.46
CWC 1000 125 V2	125	298	173	1.67

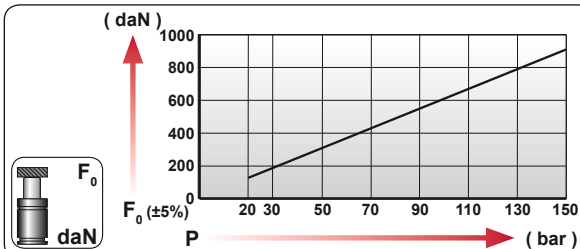

CODE		Pressure			
		bar	psi		
CWC 1000 050 V2		150	2175	920	1600
CWC-H 1000 050 V2		0	0	---	---

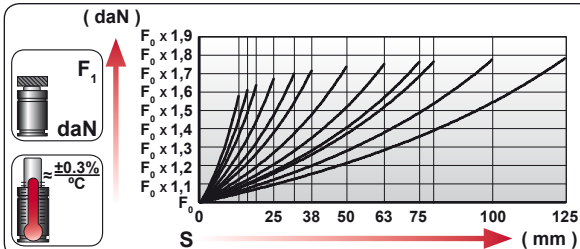

	ENG ORDER		
	DEU BESTELLUNG		
	FRA COMMANDE		
	ITA ORDINE		
	ESP PEDIDO		
POR PEDIDO			

CWC 1000 50

CWC 1000 050 V2

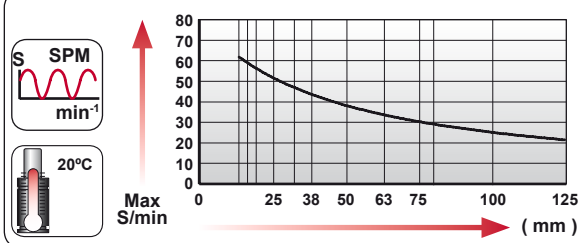

--	--	--	--	--	--	--	--

N ₂	Smax < 90%	Vmax 1,6 m/s	bar psi	bar psi	°C °F	°C °F	600 CP-
			20 290	150 2175	0 32	80 176	

	MODEL	CWC 1000

<p>CW</p> <p>KRM6 BK</p>	<p>CWC</p> <p>DRM8 TNRR</p> <p>9RM8 MCRR</p> <p>7RM8 TFRR</p> <p>SKK SGS</p>
--	---

		<p>SEAL KIT S-XXXXXXX</p>	<p>CARTRIDGE KIT C-XXXXXXX</p>		
--	--	----------------------------------	---------------------------------------	--	--

CODE	CWC 1000 050 V2	KIT S-XXXXXXX KIT C-XXXXXXX	A14-050	18 CG 1-Q
ENG	ORDER	GAS SPRING	REPAIR KIT	FLANGE
DEU	BESTELLUNG	GASDRUCKFEDER	ERSATZTEILSATZ	FLANSCH
FRA	COMMANDE	RESSORT À GAZ	KIT DE RÉPARATION	BRIDE
ITA	ORDINE	CILINDRO AD AZOTO	KIT DI MANUTENZIONE	FLANGE
ESP	PEDIDO	RESORTE DE GAS	KIT DE REPARACION	BRIDA
POR	PEDIDO	CILINDRO DE GAS	KIT DE MANUTENÇÃO	FLANGE
				CHARGING ADAPTER
				LADEADAPTER
				RACCORD DE CHARGE
				ADATTATORE DI CARICO
				ADAPTADOR DE CARGA
				ADAPTADOR DE CARGA

CWC 1000 V2 MOUNTS

Compact Height

**AZOL
GAS** 

A14-050

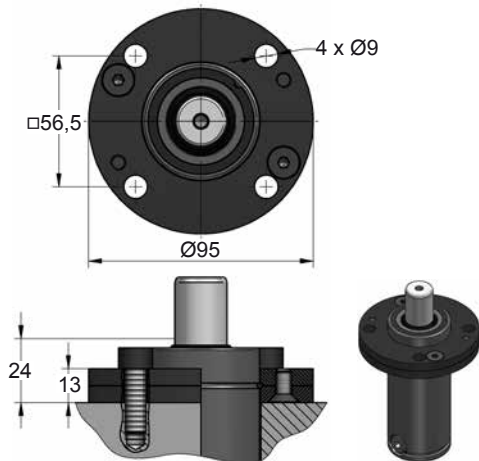

A34-050

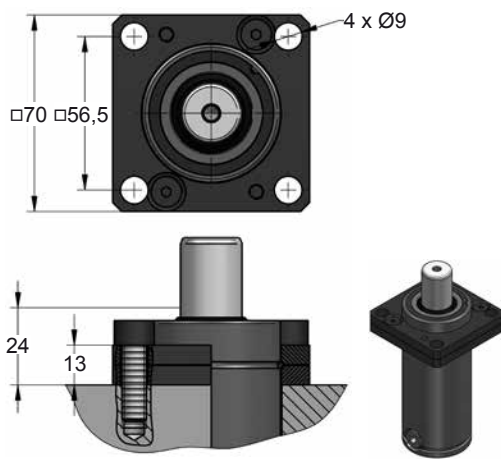

B36-050

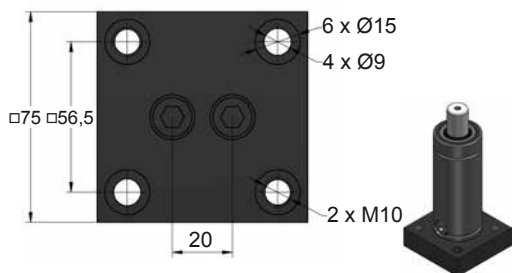
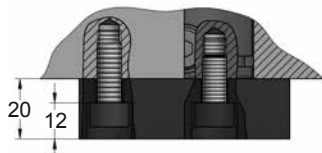

B41-050

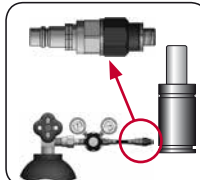
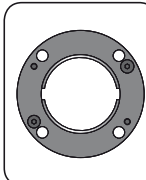
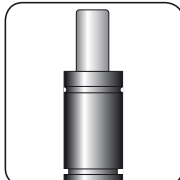
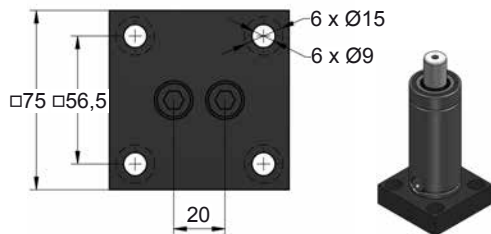
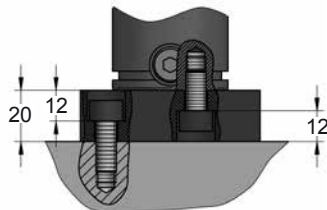

CODE	CWC 1000 050 V2	KIT S-XXXXXXX KIT C-XXXXXXX	A14-050	18 CG 1-Q	
ENG	ORDER	GAS SPRING	REPAIR KIT	FLANGE	CHARGING ADAPTER
DEU	BESTELLUNG	GASDRUCKFEDER	ERSATZTEILSATZ	FLANSCH	LADEADAPTER
FRA	COMMANDE	RESSORT À GAZ	KIT DE RÉPARATION	BRIDE	RACCORD DE CHARGE
ITA	ORDINE	CILINDRO AD AZOTO	KIT DI MANUTENZIONE	FLANGE	ADATTATORE DI CARICO
ESP	PEDIDO	RESORTE DE GAS	KIT DE REPARACION	BRIDA	ADAPTADOR DE CARGA
POR	PEDIDO	CILINDRO DE GÁS	KIT DE MANUTENÇÃO	FLANGE	ADAPTADOR DE CARGA

C05-050

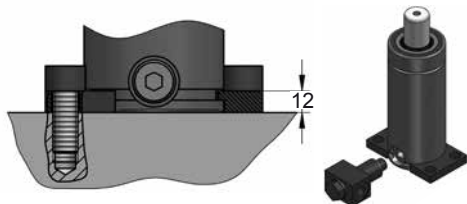
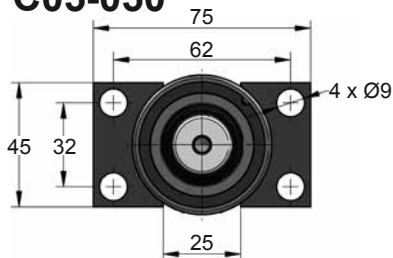

C20-050

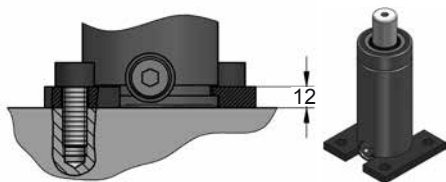
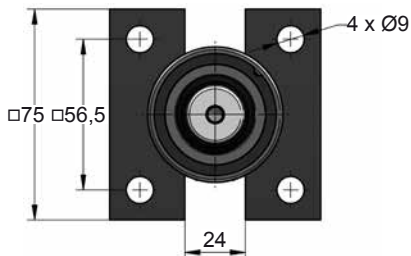

D02-050

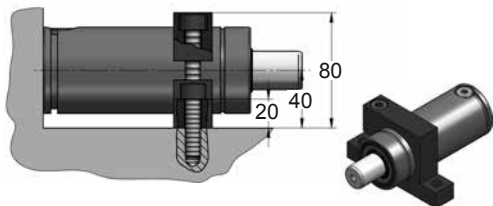
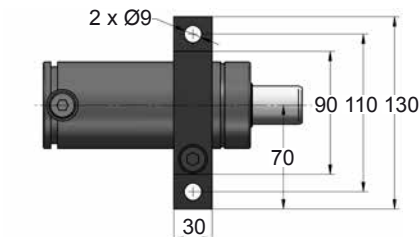

D67-050

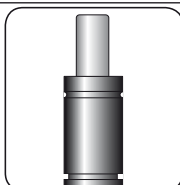
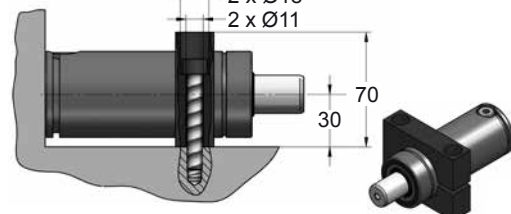
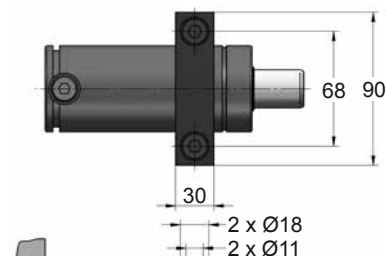

SEAL
KIT S-XXXXXXX



CARTRIDGE
KIT C-XXXXXXX

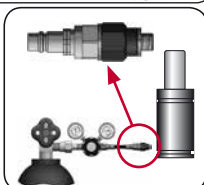
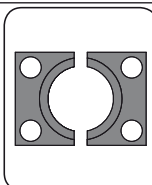

CODE	CWC 1000 050 V2	KIT S-XXXXXXX KIT C-XXXXXXX	C05-050	18 CG 1-Q	
ENG	ORDER	GAS SPRING	REPAIR KIT	FLANGE	CHARGING ADAPTER
DEU	BESTELLUNG	GASDRUCKFEDER	ERSATZTEILSATZ	FLANSCHEN	LADEADAPTER
FRA	COMMANDE	RESSORT À GAZ	KIT DE RÉPARATION	BRIDE	RACCORD DE CHARGE
ITA	ORDINE	CILINDRO AD AZOTO	KIT DI MANUTENZIONE	FLANGE	ADATTATORE DI CARICO
ESP	PEDIDO	RESORTE DE GAS	KIT DE REPARACION	BRIDA	ADAPTADOR DE CARGA
POR	PEDIDO	CILINDRO DE GÁS	KIT DE MANUTENÇÃO	FLANGE	ADAPTADOR DE CARGA