

CP-KC 2000 V2

Heavy Load

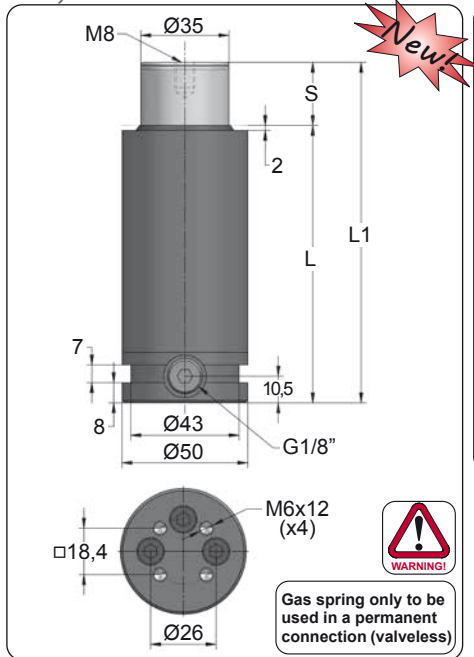

Gas spring only to be used in a permanent connection (valveless)

ORDER	S (mm)	L1 ±0,25 (mm)	L (mm)	Kg.
CP-KC 2000 010 V2	10	100	90	1.13
CP-KC 2000 015 V2	15	115	100	1.20
CP-KC 2000 025 V2	25	135	110	1.31
CP-KC 2000 038 V2	38	170	132	1.48
CP-KC 2000 050 V2	50	195	145	1.61
CP-KC 2000 063 V2	63	225	162	1.76
CP-KC 2000 080 V2	80	265	185	1.96



CODE				
	bar	psi	daN	daN
CP-KC 2000 050 V2	0	0	---	---

ENG Gas spring only to be used in a permanent connection (valveless)
 DEU Gasdruckfeder kann nur im Verbund eingesetzt werden (ohne Ventil)
 FRA Ressort à gaz ne peut être utilisé que relié dans une connexion (sans valve)
 ITA Cilindro può essere utilizzato solo in una connessione permanente (senza valvola)
 ESP Cilindro de gas sólo puede ser usado en un sistema conexionado (sin válvula)
 POR Cilindro de gás apenas pode ser utilizado em um sistema interligado (sem válvula)

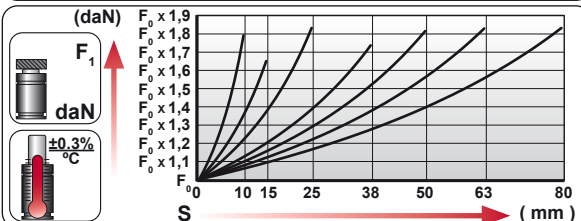
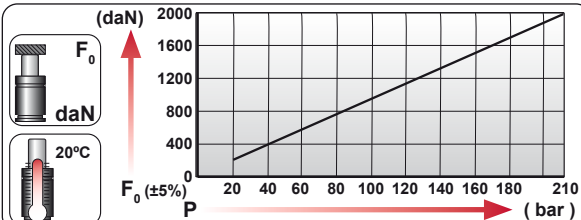

ENG ORDER		
DEU BESTELLUNG	daN	mm
FRA COMMANDE		
ITA ORDINE		
ESP PEDIDO		
POR PEDIDO		
CP-KC 2000	50	
CP-KC 2000 050 V2		

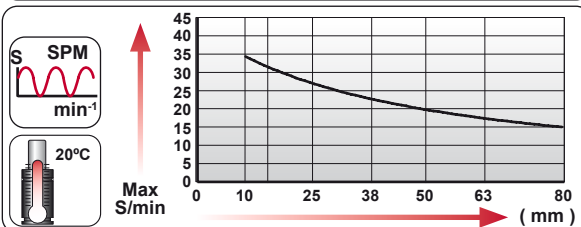

N ₂	S _{max} < 90%	V _{max} 0,5 m/s	P _{min} (20°C)	P _{max} (20°C)	T _{min}	T _{max}	

bar	psi	bar	psi	°C	°F	°C	°F	600 CP-
20	290	190	2755	0	32	80	176	

ONLY PERMANENT HOSED GAS SPRINGS

CODE					
		bar	psi	daN	daN
-----		---	---	---	---
CP-KC 2000 050 V2		0	0	---	---

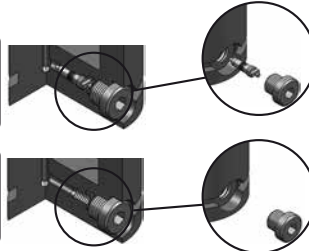

ENG	Hosed gas spring	Gas spring delivered unfilled and it can only be used in a permanent connection (valveless)
DEU	Gasdruckfeder zum verschlauchen	Gasdruckfeder wird drucklos angeliefert und kann nur im Verbund eingesetzt werden (ohne Ventil)
FRA	Ressort à gaz relié	Ressort à gaz fourni non chargé et il ne peut être utilisé que relié dans une connexion permanente (sans valve de charge)
ITA	Cilindro collegabile	Cilindro fornito scarico e può essere utilizzato solo in una connessione permanente (senza valvola unidirezionale)
ESP	Cilindro conexionable	Cilindro de gas suministrado descargado y sólo puede ser usado en un sistema conexionado permanente (sin válvula de carga)
POR	Cilindro de gas interligado	Cilindro de gás fornecido descarregado, apenas pode ser utilizado em um sistema interligado permanente (sem válvula de carga)

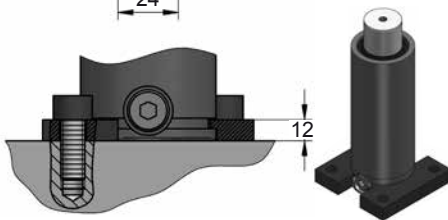
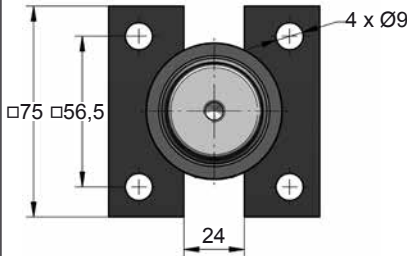
C20-050E24.54.815.G
EM24.54.700/F**KC 1800**

Gas spring only to be used in a permanent connection (valveless)

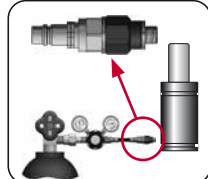
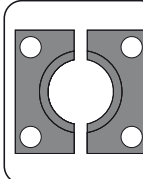
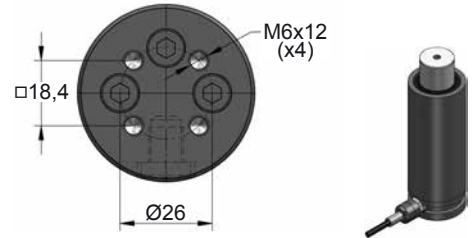
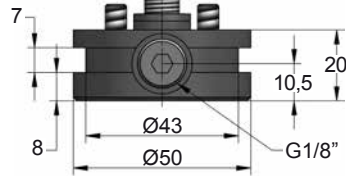

CODE	CP-KC 2000 050 V2	KIT S-XXXXXXX	C20-050	SKK 12R 1/8
ENG	ORDER	GAS SPRING	FLANGE	CHARGING ADAPTER
DEU	BESTELLUNG	GASDRUCKFEDER	FLANSCH	LADEADAPTER
FRA	COMMANDE	RESSORT À GAZ	BRIDE	RACCORD DE CHARGE
ITA	ORDINE	CILINDRO AD AZOTO	FLANGE	ADATTATORE DI CARICO
ESP	PEDIDO	RESORTE DE GAS	BRIDA	ADAPTADOR DE CARGA
POR	PEDIDO	CILINDRO DE GÁS	FLANGE	ADAPTADOR DE CARGA