

# CS-KC 4700 V1

Power Compact Stroke

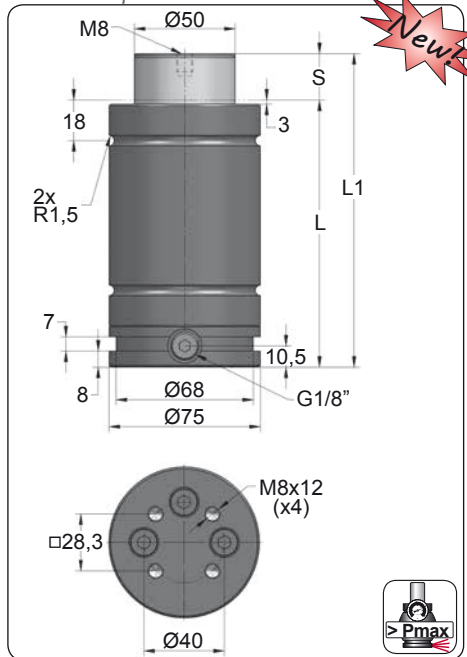

ORDER	S (mm)	L1 ±0,25 (mm)	L (mm)	Kg.
CS-KC 4700 010 V1	10	100	90	2.35
CS-KC 4700 016 V1	16	126	110	2.59
CS-KC 4700 025 V1	25	155	130	2.84
CS-KC 4700 032 V1	32	187	155	3.14
CS-KC 4700 040 V1	40	220	180	3.44
CS-KC 4700 050 V1	50	260	210	3.80
CS-KC 4700 065 V1	65	293	228	4.07

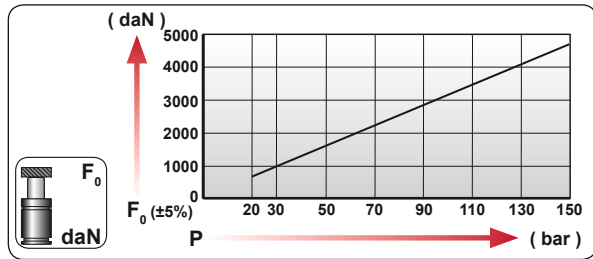

CODE				
		bar psi	daN	daN
-----		---	---	---
CS-KC 4700 050 V1		0 0	---	---

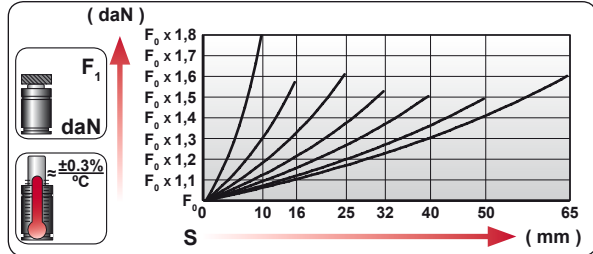

ENG ORDER	DEU BESTELLUNG	FRA COMMANDE	ITA ORDINE	ESP PEDIDO	POR PEDIDO
CS-KC 4700	50				
CS-KC 4700 050 V1					

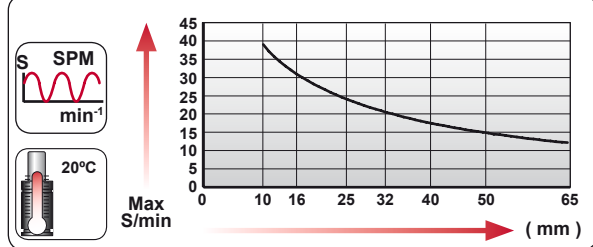

N<sub>2</sub>

S<sub>max</sub> < 90%

V<sub>max</sub> 0,5 m/s

P<sub>min</sub> (20°C)

P<sub>max</sub> (20°C)

T<sub>min</sub>

T<sub>max</sub>

600 CP-

bar psi	bar psi	°C °F	°C °F	°C °F
20 290	150 2175	0 32	80 176	



# CS-KC 4700 V1 MOUNTS

Power Compact Stroke

	<b>CS-KC</b>		<b>CS</b>																														
	<table border="1"> <thead> <tr> <th>CODE</th> <th></th> <th></th> <th></th> <th></th> </tr> <tr> <th></th> <th>bar</th> <th>psi</th> <th>daN</th> <th>daN</th> </tr> </thead> <tbody> <tr> <td>CS-KC 4700 050 V1</td> <td>0</td> <td>0</td> <td>---</td> <td>---</td> </tr> </tbody> </table>	CODE						bar	psi	daN	daN	CS-KC 4700 050 V1	0	0	---	---	<table border="1"> <thead> <tr> <th>CODE</th> <th></th> <th></th> <th></th> <th></th> </tr> <tr> <th></th> <th>bar</th> <th>psi</th> <th>daN</th> <th>daN</th> </tr> </thead> <tbody> <tr> <td>CS 4700 050 V1</td> <td>150</td> <td>2175</td> <td>4675</td> <td>6885</td> </tr> </tbody> </table>	CODE						bar	psi	daN	daN	CS 4700 050 V1	150	2175	4675	6885	
CODE																																	
	bar	psi	daN	daN																													
CS-KC 4700 050 V1	0	0	---	---																													
CODE																																	
	bar	psi	daN	daN																													
CS 4700 050 V1	150	2175	4675	6885																													

## C20-075

ISO 15723, VALVETE, VDI, EM24.54.815.G, EM24.54.700/F

## KC 4700

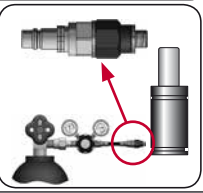
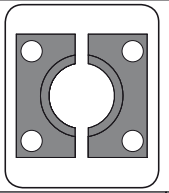
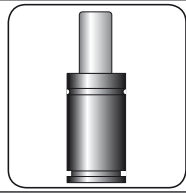

	CODE	CS-KC 4700 050 V1	KIT S-XXXXXXX	C20-075	SKK 12R 1/8
ENG	ORDER	GAS SPRING	REPAIR KIT	FLANGE	CHARGING ADAPTER
DEU	BESTELLUNG	GASDRUCKFEDER	ERSATZTEILSATZ	FLANSCH	LADEADAPTER
FRA	COMMANDE	RESSORT À GAZ	KIT DE RÉPARATION	BRIDE	RACCORD DE CHARGE
ITA	ORDINE	CILINDRO AD AZOTO	KIT DI MANUTENZIONE	FLANGE	ADATTATORE DI CARICO
ESP	PEDIDO	RESORTE DE GAS	KIT DE REPARACION	BRIDA	ADAPTADOR DE CARGA
POR	PEDIDO	CILINDRO DE GÁS	KIT DE MANUTENÇÃO	FLANGE	ADAPTADOR DE CARGA