

GP

EXTERNAL GEAR PUMPS SERIES 20

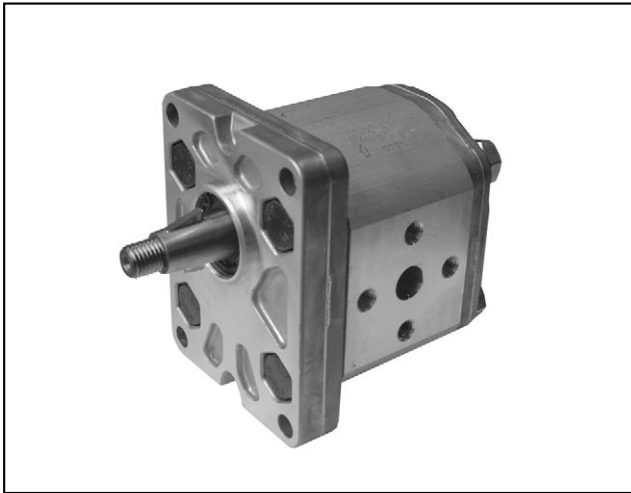

OPERATING PRINCIPLE

- The GP pumps are fixed displacement external gear pumps with axial clearance compensation.
- They give high volumetric efficiency even with high operating pressures, a low noise level, and they have a high endurance thanks to the balancing system of the loads on the guide bushings.
- They are divided into three size groups, with displacements of up to 9.1 - 27.9 and 87.6 cm³/rev respectively, and with operating pressures of up to 250 bar (standard) and up to 310 bar (H version for high pressure).
- They are available with clockwise, anticlockwise and reversible rotation, with tapered shaft (standard). Other kind of shaft are available upon request.
- They are available in multiple versions, and can be combined in multi-flow groups, with a splined connection motion system that guarantees high power performances.

TECHNICAL SPECIFICATIONS

GP PUMP SIZE		GP1	GP2	GP3
Displacement range	cm ³ /rev	1.3 ÷ 9.1	7 ÷ 27.9	20.7 ÷ 87.6
Flow rate and operating pressures		see table 3 - Performances		
Rotation speed		see table 3 - Performances		
Rotation direction		clockwise, anticlockwise or reversible (seen from the shaft side)		
Loads on the shaft		radial and axial load are not allowed		
Max torque applicable to the shaft		see paragraph 14.1		
Hydraulic connection		flanged fittings (see paragraph 16)		
Type of mounting		4-holes flange - rectangular type		
Mass: standard version H version	kg	1.2 ÷ 1.6 1.9 ÷ 2.3	2.6 ÷ 3.5 3.8 ÷ 4.7	6 ÷ 8.5 8.7 ÷ 11.2

Ambient temperature range	°C	-20 / +50
Fluid temperature range	°C	-15 / +80
Fluid viscosity range		see paragraph 2.2
Fluid contamination degree		see paragraph 2.3
Recommended viscosity	cSt	25 ÷ 100

HYDRAULIC SYMBOL

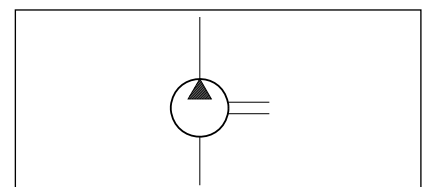

1 - IDENTIFICATION CODE

1.1 - Identification code for single and front pumps

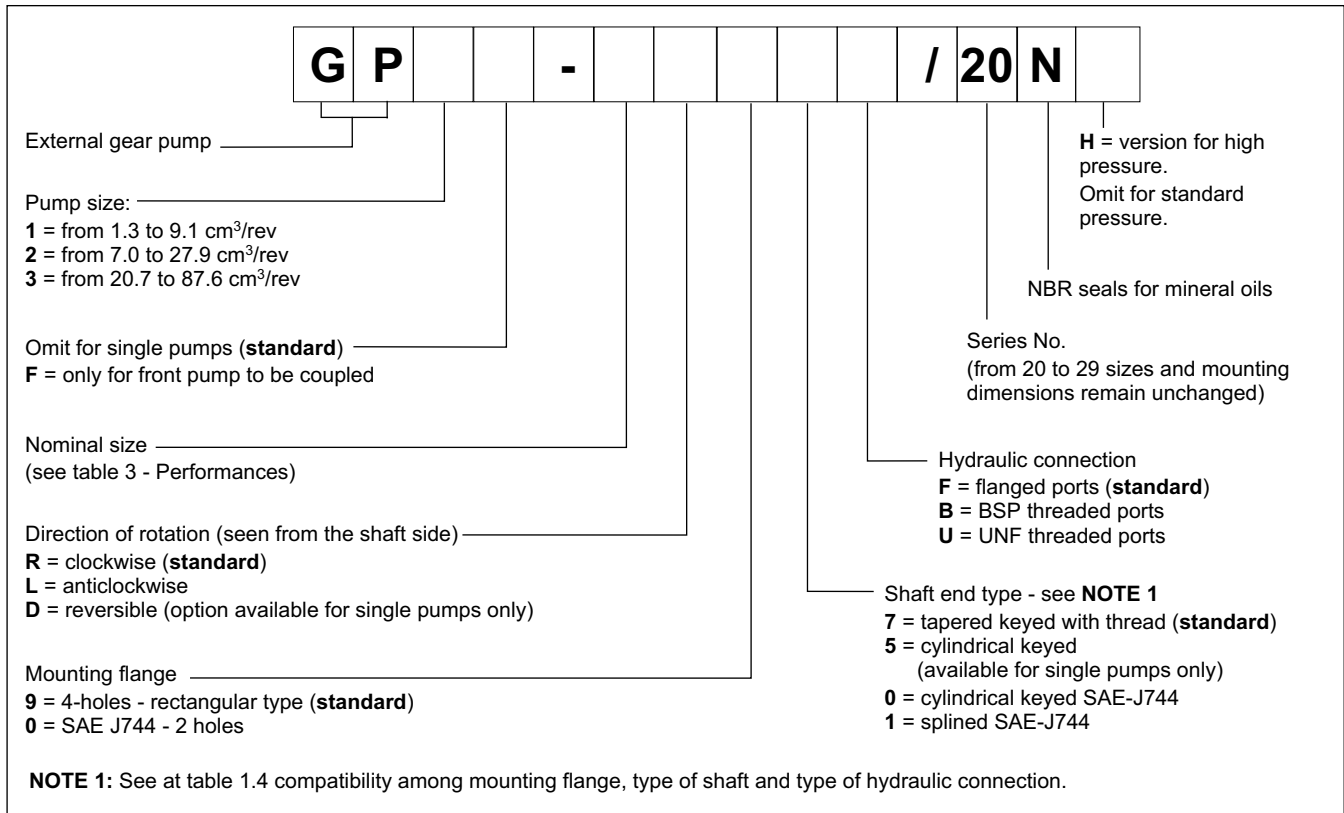

1.2 - Identification code for intermediate and rear pumps

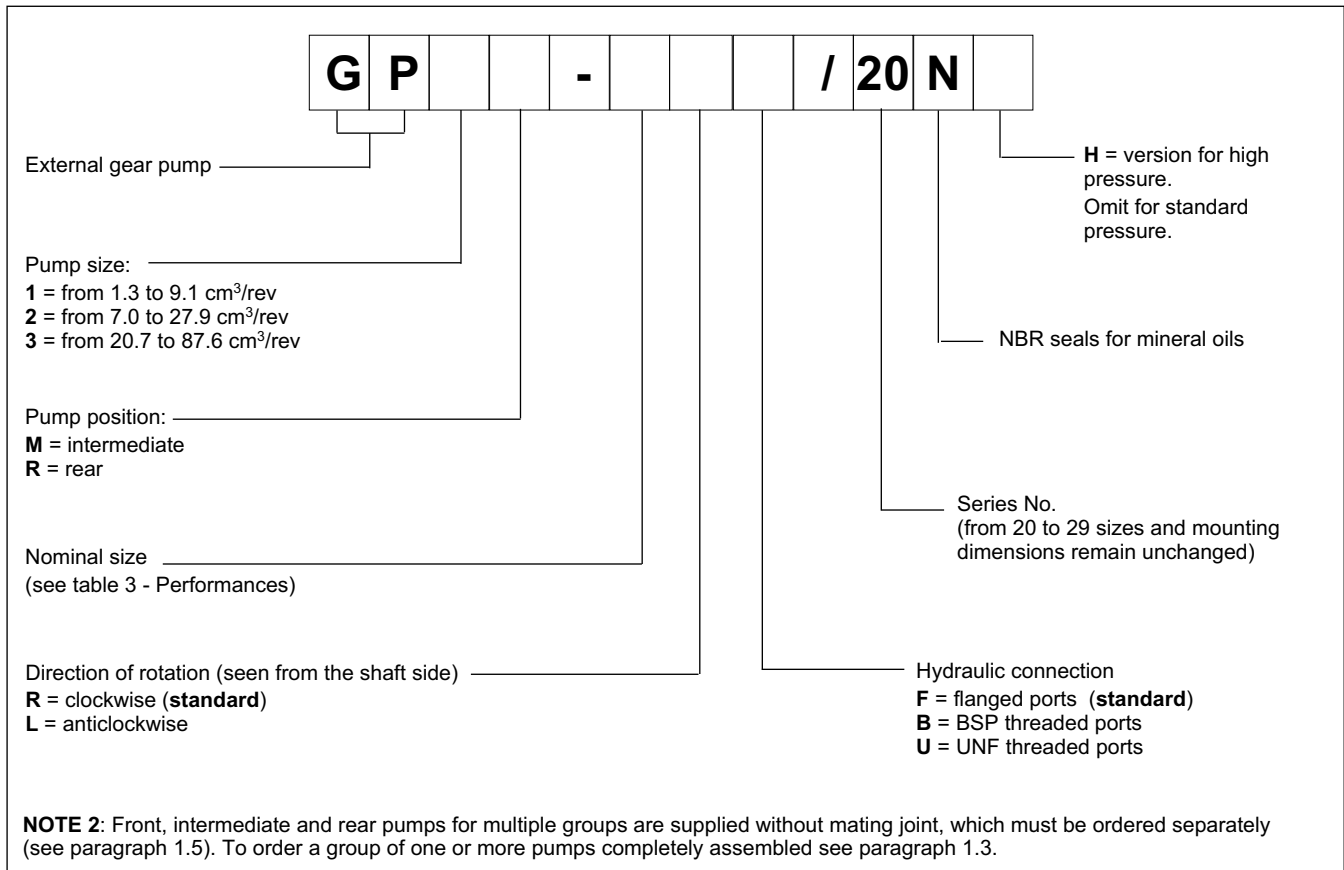

1.3 - Identification code for multiple pumps

identification code front pump + identification code intermediate pump (omit for double pumps) + identification code rear pump

1.4 - Compatibility among mounting flange, type of shaft and type of hydraulic connection

FLANGE CODE	SHAFT CODE				HYDRAULIC CONNECTION CODE		
	7	5	0	1	F	B	U
9	yes	yes	no	no	yes	yes	no
0	no	no	yes	yes	yes	no	yes

1.5 - Identification code for mating joints

FIRST PUMP	SECOND PUMP		
	GP1	GP2	GP3
GP1	3101100003	-	-
GP2	3101100004	3101100005	-
GP3	3101100006	3101100007	3101100008

1.6 - Examples

a) single pump size 1 - 1.3 cm³/rev - anticlockwise rotation - standard flange and shaft

GP1-0013L97F/20N

b) single pump size 2 - 14 cm³/rev - clockwise rotation - standard flange and shaft

GP2-0140R97F/20N

c) single pump size 3 - 22.5 cm³/rev - clockwise rotation - SAE flange and shaft

GP3-0225R01F/20N

d) double pump made of:

- pump size 2 - 7 cm³/rev - clockwise rotation
- pump size 1 - 2 cm³/rev - high pressure

GP2F-0070R97F/20N + GP1R-0020RF/20NH

e) triple pump made of:

- pump size 3 - 22.5 cm³/rev
- pump size 2 - 14 cm³/rev
- pump size 1 - 2 cm³/rev

GP3F-0225R97F/20N + GP2M-0140RF/20N + GP1R-0020RF/20N

2 - HYDRAULIC FLUID
2.1 Type of fluid

Use mineral oil based hydraulic fluids with anti-foam and antioxidant additives, in conformity with the requisites of the following standards:

- FZG test - 11th stage
- DIN 51525
- VDMA 24317

For use with other types of fluid (water glycol, phosphate esters and others), consult our technical dept. Operation with fluid at a temperature greater than 80°C causes a premature deterioration of the fluid quality and of the seals. The physical and chemical properties of the fluid must be maintained.

2.2 - Fluid viscosity

The operating fluid viscosity must be within the following range:

minimum viscosity	12 cSt	referred to the maximum fluid temperature of 80 °C
optimum viscosity	25 + 100 cSt	referred to the operating temperature of the fluid in the tank
maximum viscosity	1600 cSt	limited to only the start-up phase of the pump

2.3 - Degree of fluid contamination

The maximum degree of fluid contamination must be according to ISO 4406:1999 class 20/18/15; therefore, use of a filter with $\beta_{20} \geq 75$ is recommended. A degree of maximum fluid contamination according to ISO 4406:1999 class 18/16/13 is recommended for optimum endurance of the pump. Hence, use of a filter with $\beta_{10} \geq 100$ is recommended.

If there is a filter installed on the suction line, be sure that the pressure at the pump inlet is not lower than the values specified in paragraph 13. The suction filter must be equipped with a by-pass valve and, if possible, with a clogging indicator.

3 - PERFORMANCE RATINGS

(values obtained with mineral oil with viscosity of 36 cSt at 50°C)

Values in brackets refer to the version **H**, for high pressure. The max pressure values for reversible high pressure pumps (rotation type **D**) must be reduced by 15%.

PUMP SIZE	NOMINAL SIZE	DISPLACEMENT [cm ³ /rev]	MAX FLOW RATE at 1500 rpm [l/min]	MAX PRESSURE at 1500 rpm [bar]		SPEED [rpm]		
				continuous operating	peak	max flange = 9	max flange = 0	min
GP1	0013	1.3	2.0	250 (270)	290 (310)	6000	6000	800
	0020	2.0	3.0					
	0027	2.7	4.0					
	0034	3.4	5.1					
	0041	4.1	6.1	230 (260)	260 (290)	4000	4000	
	0051	5.1	7.6			4000	3500	
	0061	6.1	9.1	3800	3000			
	0074	7.4	11.1	200 (230)	230 (290)	3200	3500	
0091	9.1	13.6	180 (210)	210 (240)	2600	3000		
GP2	0070	7.0	10.5	250 (280)	290 (310)	4000	4000	600
	0095	9.5	14.2			3000		
	0113	11.3	16.9	230 (280)	270 (310)	4000	4000	
	0140	14.0	21.0	230 (260)	270 (300)		3200	
	0158	15.8	23.7	210 (260)	240 (290)	3600	3800	500
	0178	17.8	26.7				2500	
	0208	20.8	31.2	180 (230)	210 (260)	3200	2200	
	0234	23.4	35.1			3000	2000	
0279	27.9	41.8	170 (200)	200 (230)	2500	1800		
GP3	0207	20.7	31.0	230 (280)	270 (310)	3500	3500	500
	0225	22.5	33.7					
	0264	26.4	39.6					
	0337	33.7	50.5	230 (270)	270 (300)	3000	3300	
	0394	39.4	59.1	220 (260)	260 (290)		3000	
	0427	42.7	64.0	210 (250)	250 (280)	2800	2800	400
	0514	51.4	77.1	200 (230)	240 (260)	2400	2500	
	0600	60.0	90.0	190 (210)	220 (240)	2800	2800	
	0696	69.6	104.4	170 (200)	200 (230)	2500	2500	
	0776	77.6	116.4	160 (180)	190 (210)	2300	2300	
0876	87.6	131.4	140 (160)	170 (190)	2000	2000		

4 - CURVES AND CHARACTERISTIC DATA OF GROUP GP1 PUMPS

(values obtained with mineral oil with viscosity of 36 cSt at 50°C)

4.1 - Flow rate curves $Q = f(n)$ obtained with operating pressure 0 bar

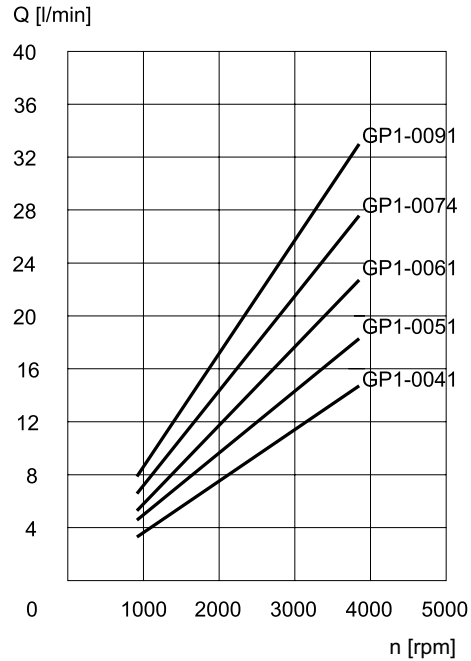
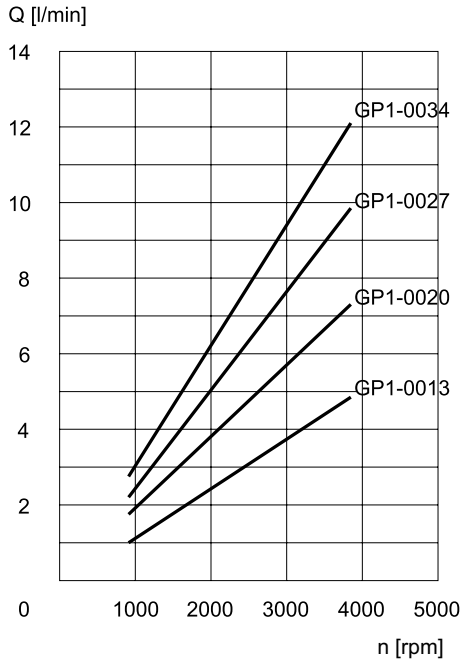

4.2 - Efficiencies

PUMP NOMINAL SIZE	VOLUMETRIC EFFICIENCY [%]	TOTAL EFFICIENCY [%]
0013	0.90	0.82
0020	0.90	0.85
0027	0.95	0.90
0034	0.91	0.87
0041	0.94	0.90
0051	0.96	0.92
0061	0.96	0.92
0074	0.96	0.90
0091	0.96	0.88

The volumetric and total efficiencies for the various nominal dimensions of the Group GP1 pumps, measured at 1500 rpm and with 150 bar operating pressure, are shown in the table.

The total efficiency considers the volumetric efficiency and the mechanical efficiency of the pump in the specified operating conditions.

4.3 - Noise level

PUMP NOMINAL SIZE	NOISE LEVEL [dB (A)]
0013	65
0020	66
0027	68
0034	68
0041	70
0051	73
0061	73
0074	73
0091	77

The noise levels for the various nominal dimensions of the Group GP1 pumps, measured at 1500 rpm, with 150 bar operating pressure and measured at a distance of 1 metre from the pump, are shown in the table.

4.4 - Absorbed power curves $N = f(n)$, obtained with operating pressures from 50 to 250 bar

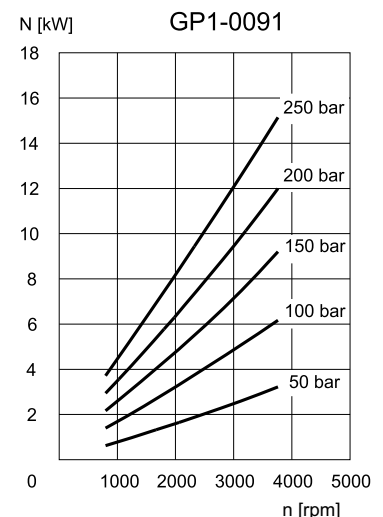
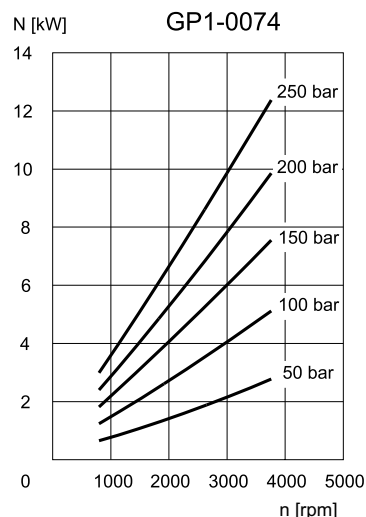
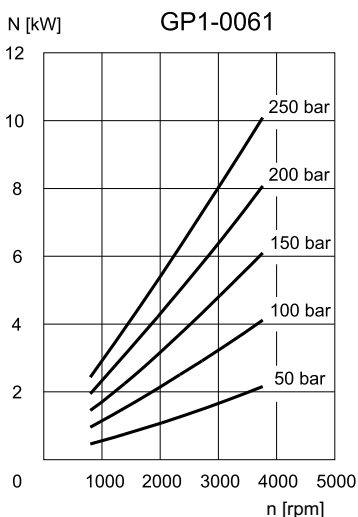
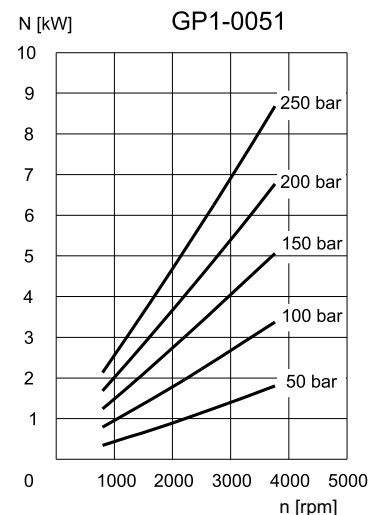
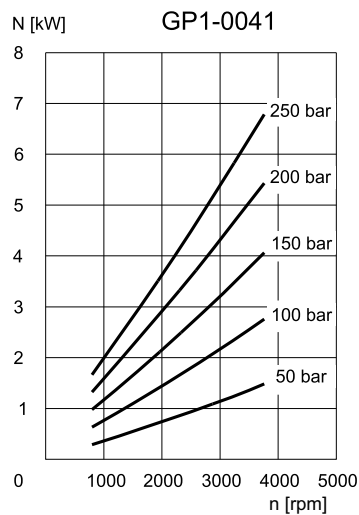
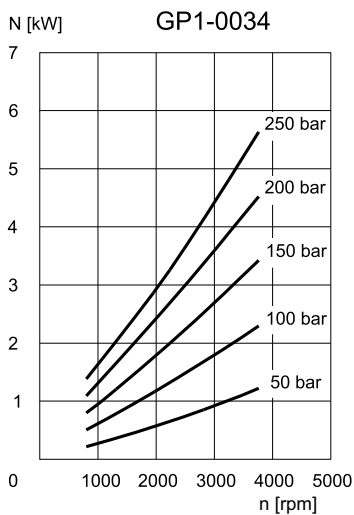
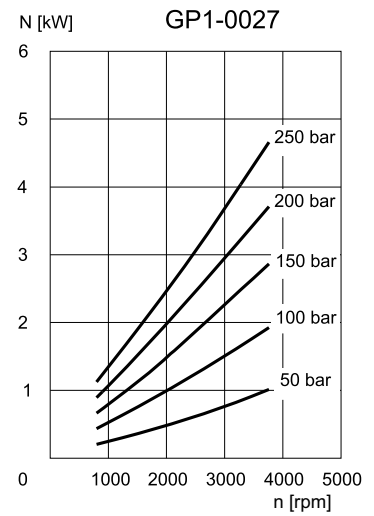
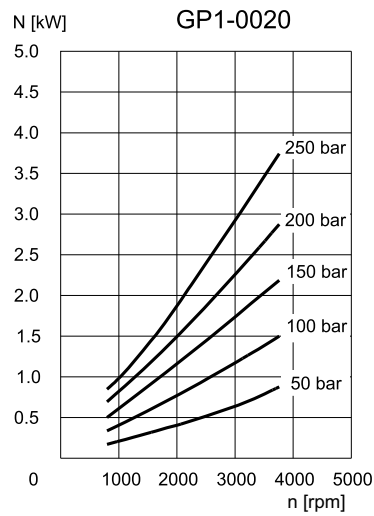
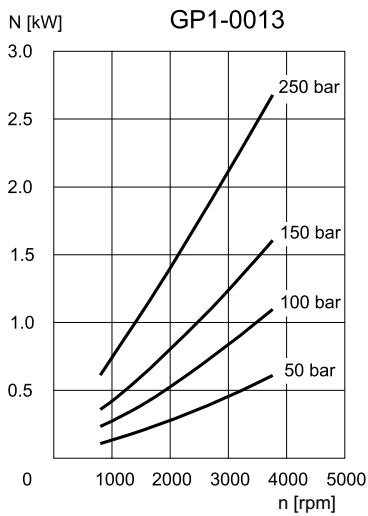

5 - CURVES AND CHARACTERISTIC DATA OF GROUP GP2 PUMPS

(values obtained with mineral oil with viscosity of 36 cSt at 50°C)

5.1 - Flow rate curves $Q = f(n)$ obtained with operating pressure 0 bar

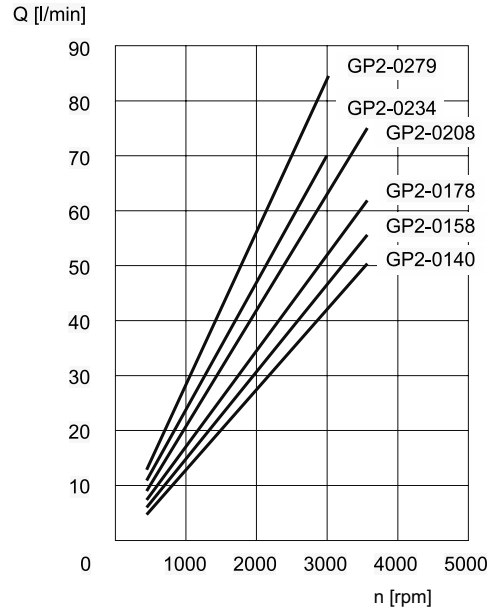
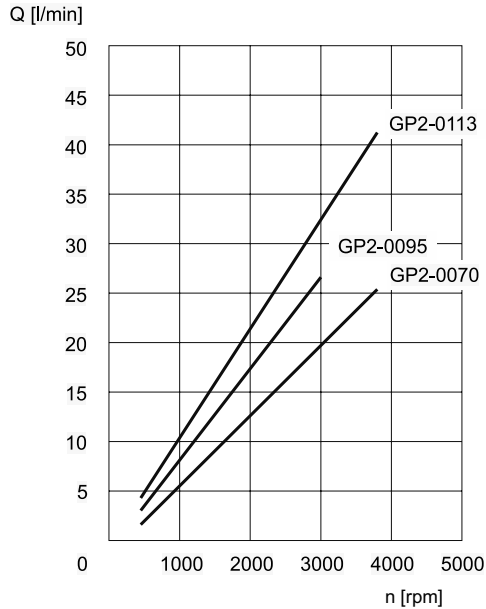

5.2 - Efficiencies

PUMP NOMINAL SIZE	VOLUMETRIC EFFICIENCY [%]	TOTAL EFFICIENCY [%]
0070	0.92	0.87
0095	0.95	0.88
0113	0.95	0.87
0140	0.93	0.87
0158	0.95	0.86
0178	0.93	0.85
0208	0.93	0.88
0234	0.97	0.89
0279	0.94	0.85

The volumetric and total efficiencies for the various nominal dimensions of the Group GP2 pumps, measured at 1500 rpm and with 150 bar operating pressure, are shown in the table.

The total efficiency considers the volumetric efficiency and the mechanical efficiency of the pump in the specified operating conditions.

5.3 - Noise level

PUMP NOMINAL SIZE	NOISE LEVEL [dB (A)]
0070	75
0095	77
0113	77
0140	72
0158	72
0178	73
0208	74
0234	76
0279	76

The noise levels for the various nominal dimensions of the Group GP2 pumps, measured at 1500 rpm, with 150 bar operating pressure and measured at a distance of 1 metre from the pump, are shown in the table.



5.4 - Absorbed power curves $N = f(n)$, measured with operating pressures from 50 to 250 bar

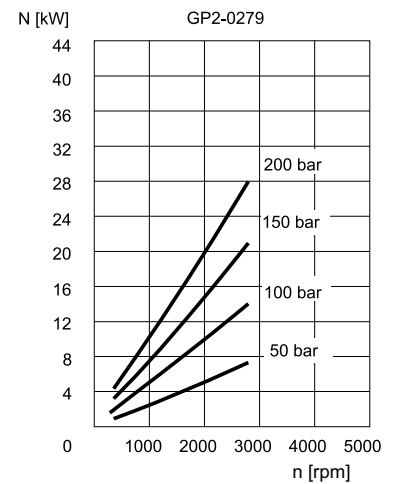
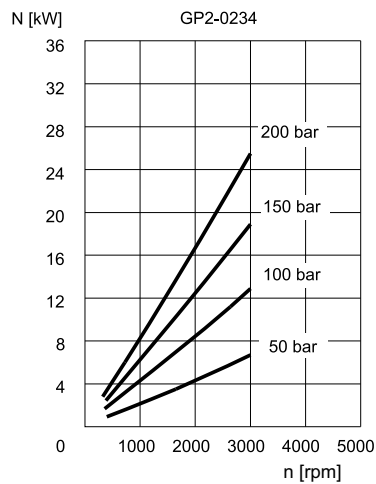
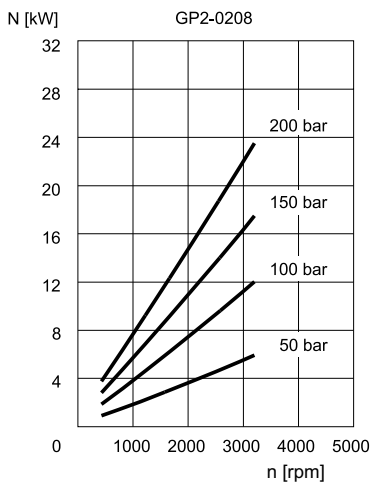
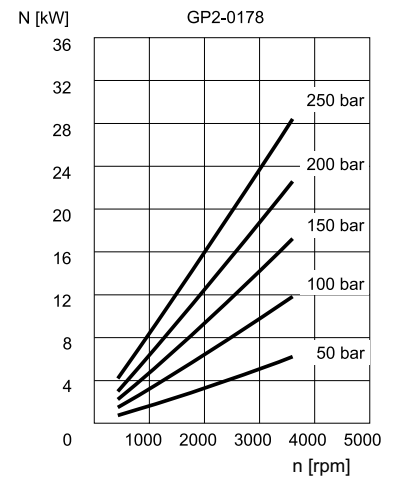
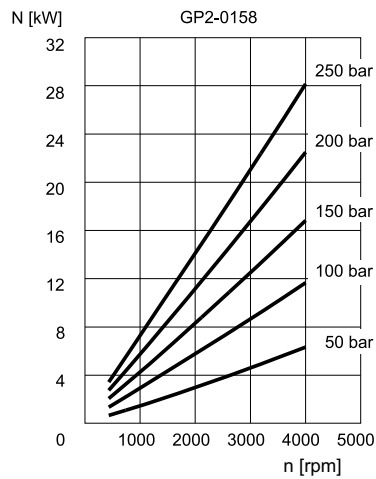
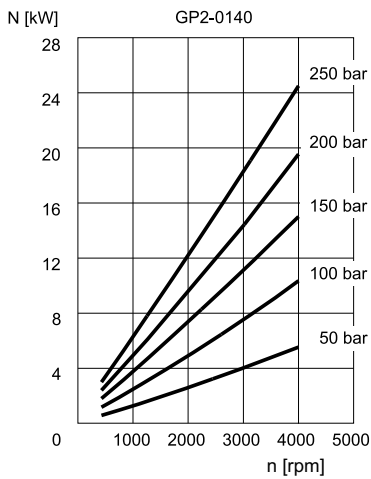
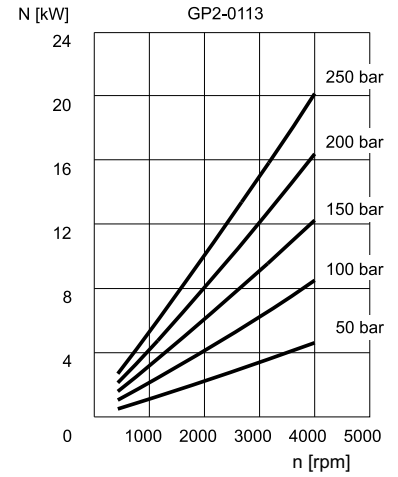
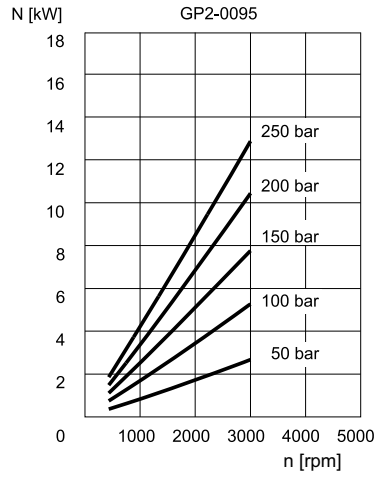
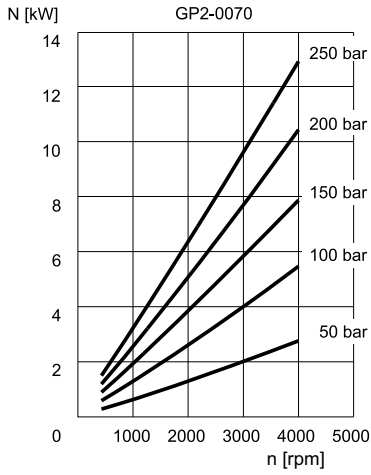

6 - CURVES AND CHARACTERISTIC DATA OF GROUP GP3 PUMPS

(values obtained with mineral oil with viscosity of 36 cSt at 50°C)

6.1 - Flow rate curves $Q = f(n)$ obtained with operating pressure 0 bar

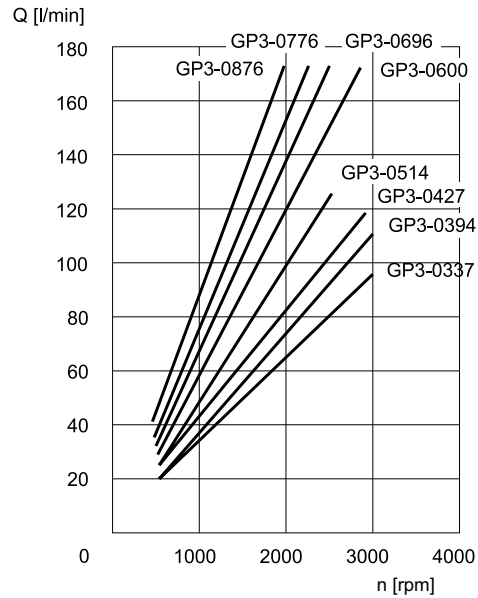
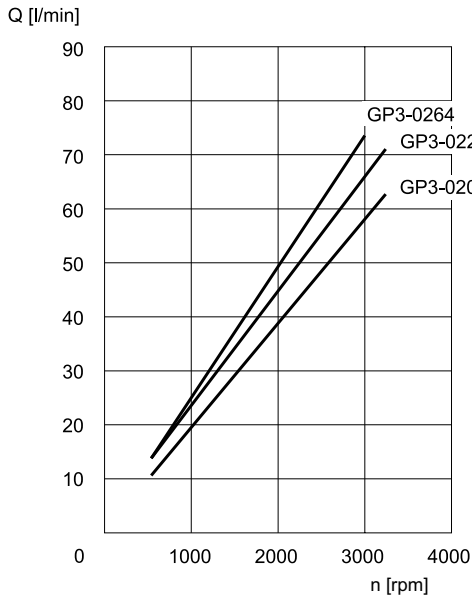

6.2 - Efficiencies

PUMP NOMINAL SIZE	VOLUMETRIC EFFICIENCY [%]	TOTAL EFFICIENCY [%]
0207	0.88	0.83
0225	0.97	0.92
0264	0.90	0.84
0337	0.92	0.87
0394	0.91	0.86
0427	0.92	0.82
0514	0.93	0.83
0600	0.85	0.82
0696	0.95	0.90
0776	0.93	0.87
0876	0.89	0.84

The volumetric and total efficiencies for the various nominal dimensions of the Group GP3 pumps, measured at 1500 rpm and with 150 bar operating pressure, are shown in the table.

The total efficiency considers the volumetric efficiency and the mechanical efficiency of the pump in the specified operating conditions.

6.3 - Noise level

PUMP NOMINAL SIZE	NOISE LEVEL [dB (A)]
0207	75
0225	75
0264	76
0337	72
0394	72
0427	73
0514	75
0600	77
0696	77
0776	76
0876	78

The noise levels for the various nominal dimensions of the Group GP3 pumps, measured at 1500 rpm, with 150 bar operating pressure and measured at a distance of 1 metre from the pump, are shown in the table.

6.4 - Absorbed power curves $N = f(n)$, obtained with operating pressures from 50 to 250 bar

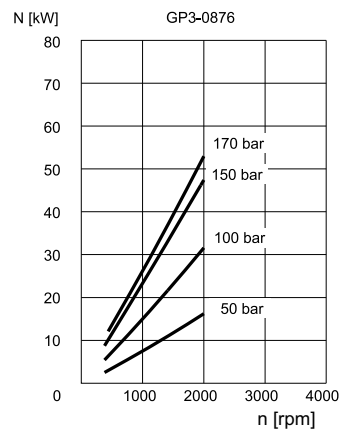
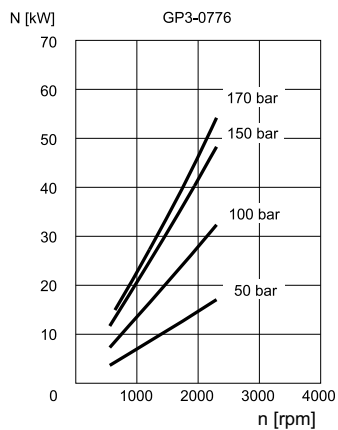
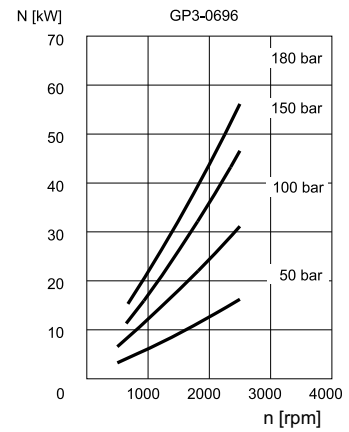
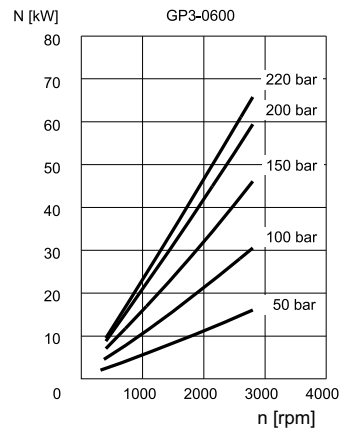
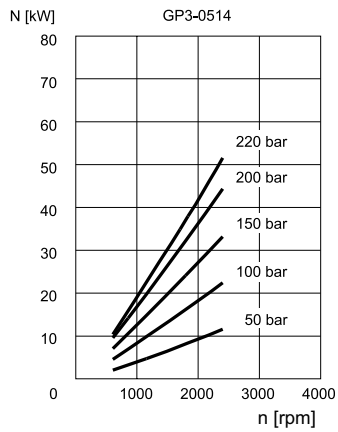
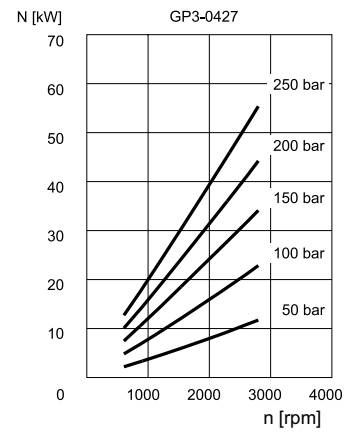
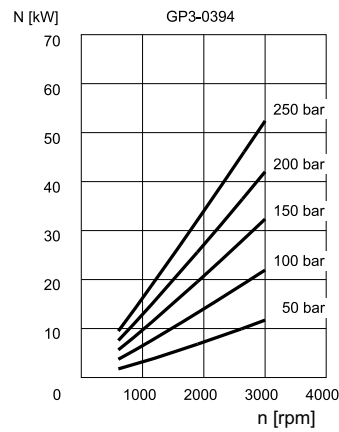
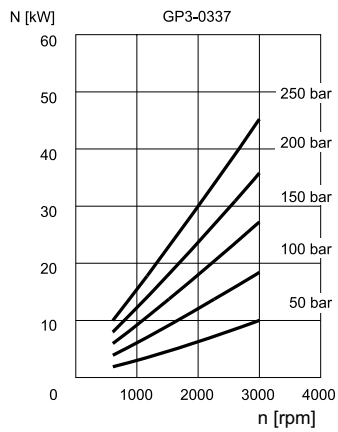
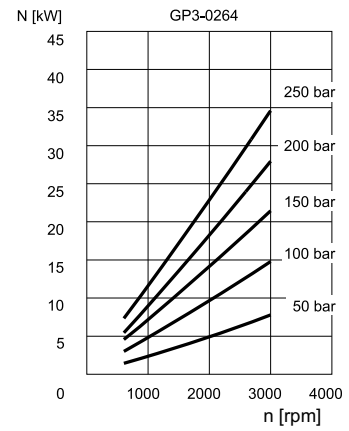
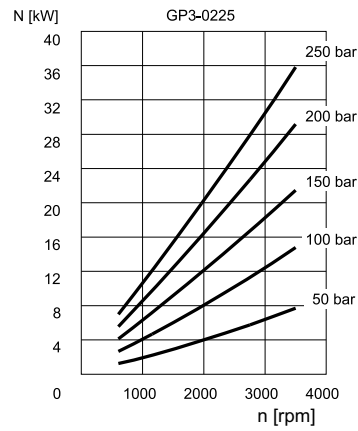
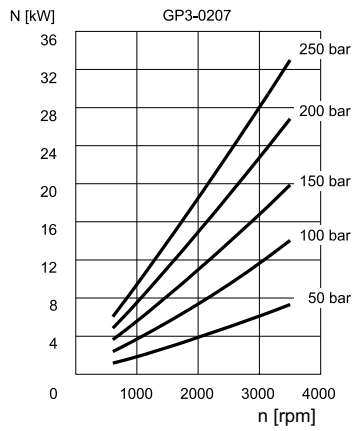

7 - GP1 PUMPS WITH STANDARD FLANGE - OVERALL AND MOUNTING DIMENSIONS

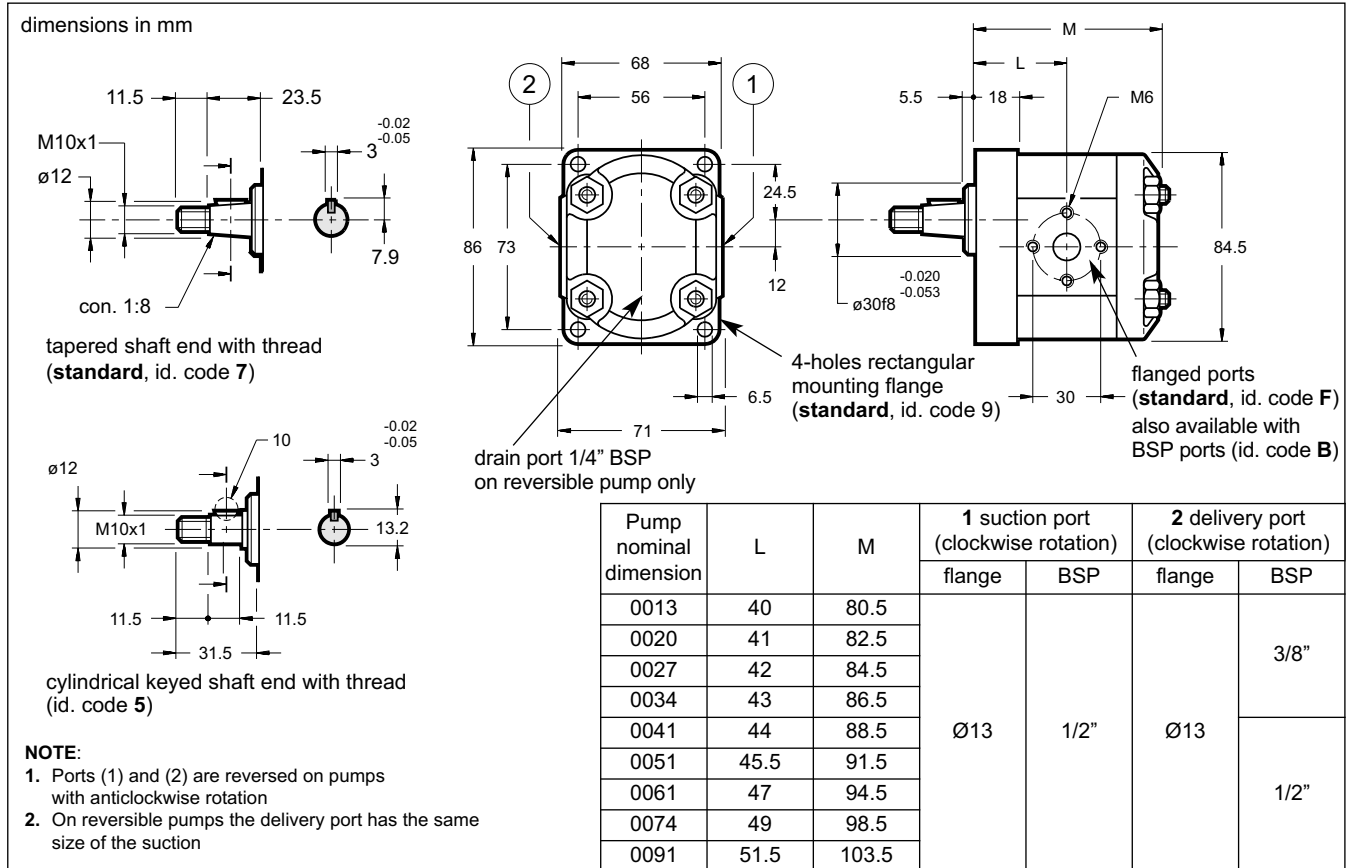

8 - GP1 PUMPS WITH SAE FLANGE - OVERALL AND MOUNTING DIMENSIONS

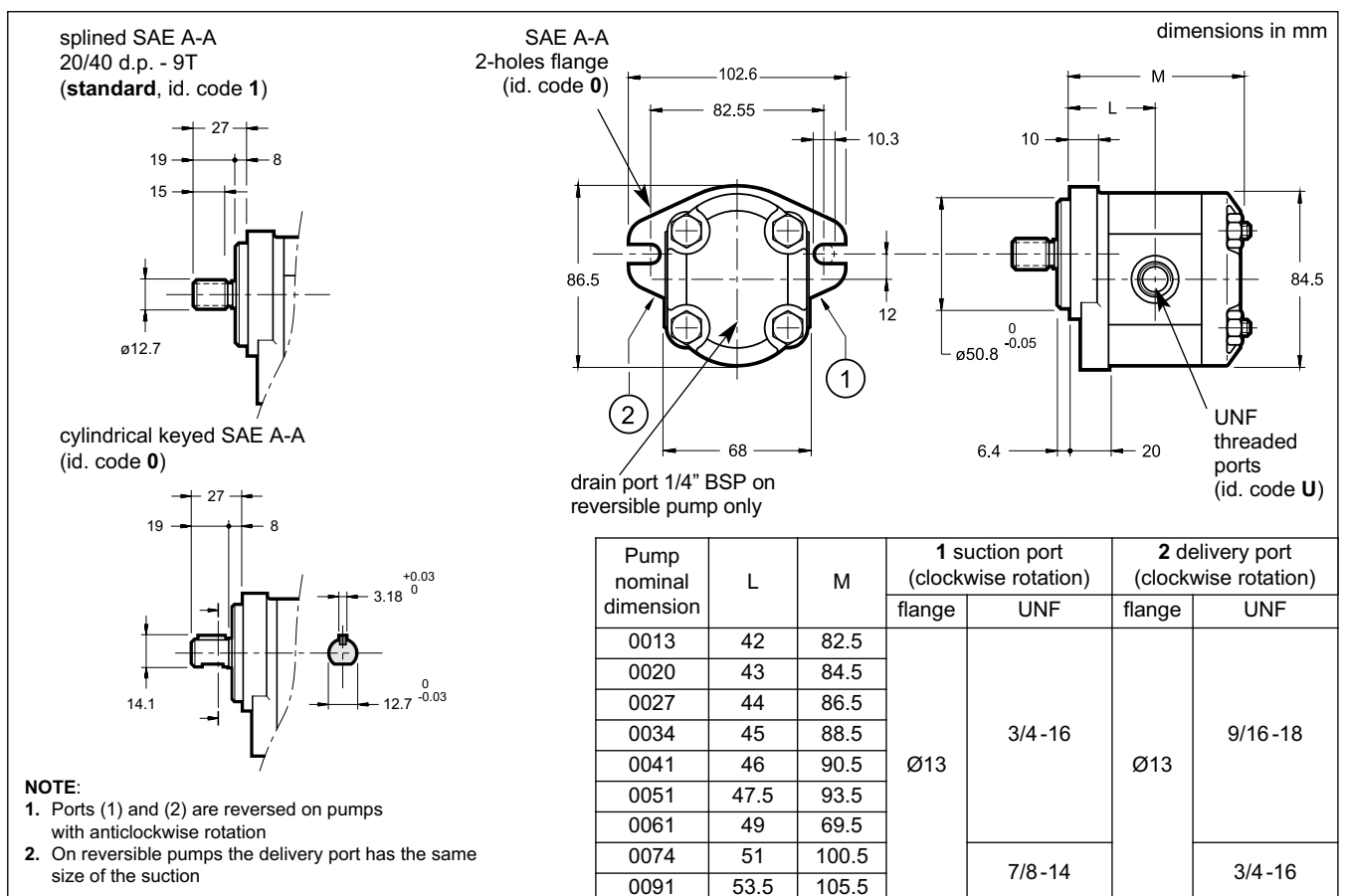

11 - GP3 PUMPS WITH STANDARD FLANGE - OVERALL AND MOUNTING DIMENSIONS

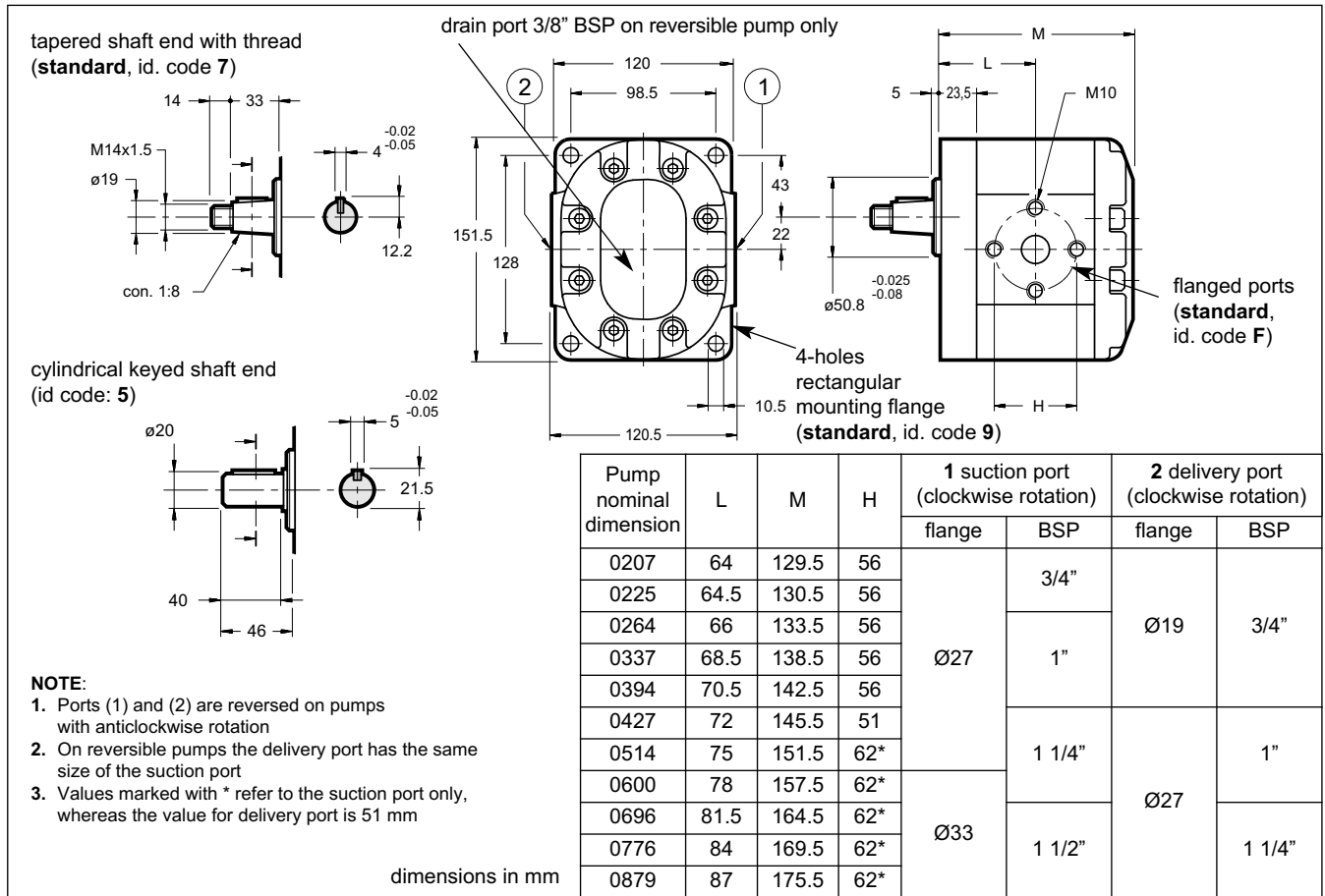

12 - GP3 PUMPS WITH SAE FLANGE - OVERALL AND MOUNTING DIMENSIONS

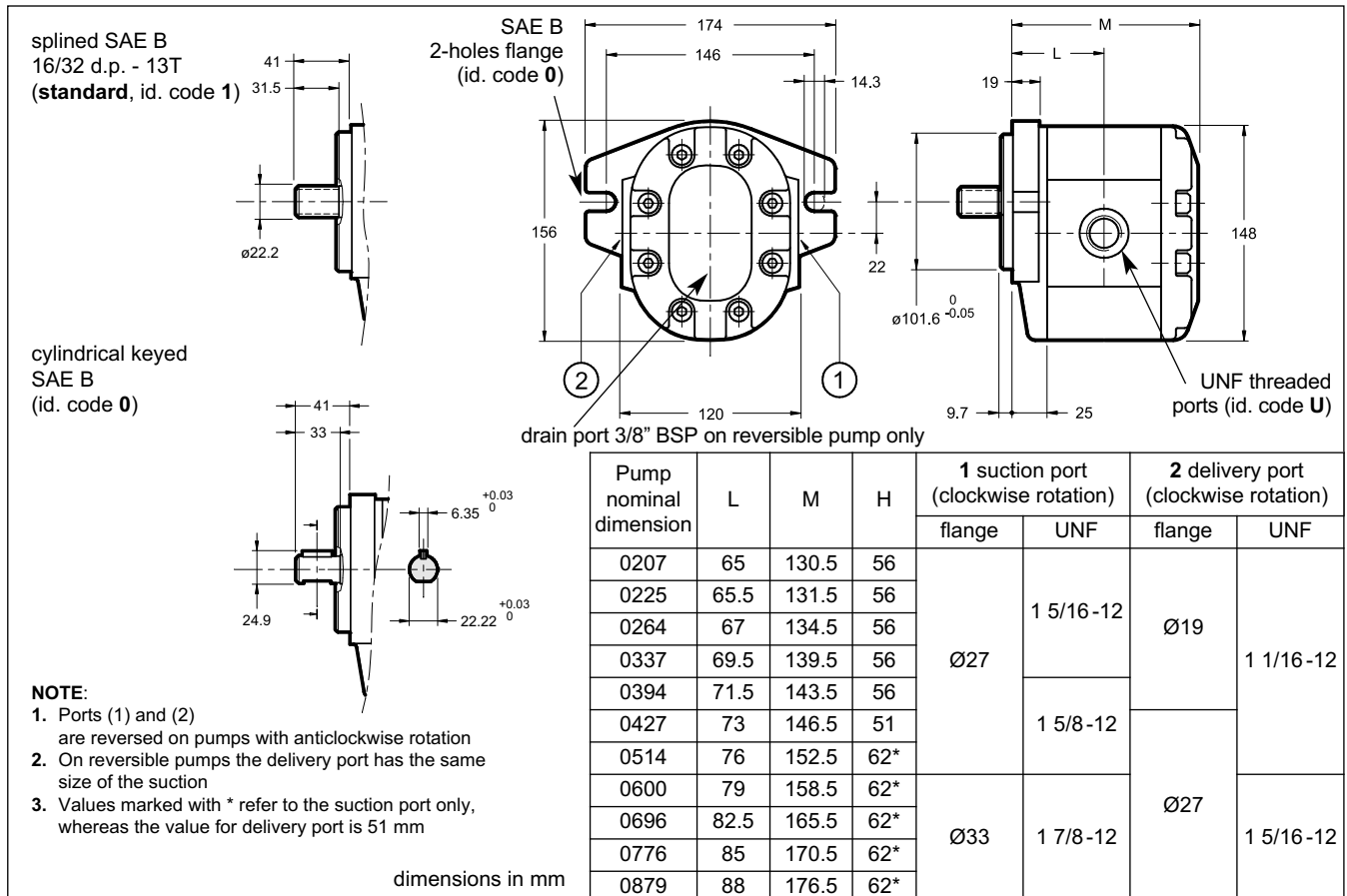

13 - INSTALLATION

- The GP gear pumps can be installed with shaft oriented in any position.
- Check that the rotation direction of the motor corresponds to the direction of the arrow marked on the pump before commissioning.
- Before the first start up vent the air from the delivery port.
- The pump start up, especially at a cold temperature, should occur with the pump unloading.
- The suction pipe must be suitably sized to facilitate the passage of the fluid. Bends and restrictions or an excessive length of the pipeline can affect the correct operation of the pump. It is advisable not to exceed the speed of 1 ± 2 m/sec in suction hose.
- The minimum permissible suction pressure is -0.3 bar relative. Standard pumps cannot work with pressure at suction port, except reversible pumps, which are able to withstand pressurized inlet
- Gear pumps must not operate with a rotation speed lower than the minimum rotation speed indicated in table 3 - performance. **The pumps must be filled with the same operating fluid as the circuit before being installed.** Filling can be done through the ports connections. Rotate the pump manually if needed.
- The motor-pump connection must be carried out directly with a flexible coupling able to compensate any offsets. Couplings that generate axial or radial loads on the pump shaft are not allowed.
- The drain port of the reversible pumps must always be connected to the tank. Maximum permitted pressure rise is 6 bar

14 - MULTIPLE PUMPS

It's possible to create multi-flow groups with independent hydraulic circuits coupling several pumps together. While sizing multiple pumps the following conditions must be taken into account:

- Assembly can take place between pumps of the same group, or in decreasing order of size.
- The max. rotation speed is determined by the pump with the lowest speed.
- The values of the max. applicable torque can not be exceeded.

14.1 - Maximum applicable torque

The input torque (M) is given for each pump by the following ratio:

$$M = \frac{9550 \cdot N}{n} = [\text{Nm}] \quad n = \text{rotation speed [rpm]}$$

where the absorbed power (N) is given by:

$$N = \frac{Q \cdot \Delta p}{600 \cdot \eta_{\text{tot}}} = [\text{kW}] \quad \begin{aligned} Q &= \text{flow rate [l/min]} \\ \Delta p &= \text{differential pressure between the pump suction and delivery [bar]} \\ \eta_{\text{tot}} &= \text{total efficiency (see diagrams in par. 4.2 - 5.2 - 6.2).} \end{aligned}$$

or it can be obtained from the diagrams ABSORBED POWER (see paragraphs 4.4 - 5.4 - 6.4).

If several pumps are coupled, the torque of each single pump has to be added to the torque of subsequent pumps when they are loaded simultaneously.

The obtained torque value for each pump has to be lower than the value specified in the table below.

If the obtained torque values are higher than those stated in the table, reduce the working pressure value or replace the overloaded pump with a pump suitable to bear the required torque.

	MAX APPLICABLE TORQUE [Nm]					
	Front pump shaft type			Intermediate / rear pump		
front pump size	tapered, keyed code 7	SAE J744 splined code 1	SAE J744 cylindrical keyed code 0	GP1	GP2	GP3
GP1	90	55	55	50	-	-
GP2	145	110	105		110	-
GP3	280	405	295			230

15 - MULTIPLE PUMPS OVERALL DIMENSIONS

Dimensions below are concerning to standard pumps (clockwise rotation, rectangular flange, tapered keyed with thread shaft end and flanged ports). Please consult our Technical Dept. for different configurations and for overall dimensions of groups composed by three or more pumps.

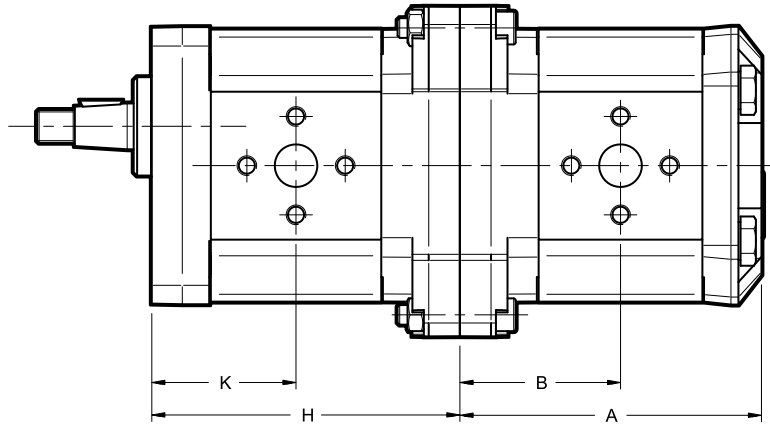

dimensions in mm

PUMP SIZE	NOMINAL SIZE	FRONT PUMP		REAR PUMP	
		H	K	A	B
GP1	0013	86	40	86,5	46
	0020	88	41	88,5	47
	0027	90	42	90,5	48
	0034	92	43	92,5	49
	0041	94	44	94,5	50
	0051	97	45,5	97,5	51,5
	0061	100	47	100,5	53
	0074	104	49	104,5	55
	0091	109	51,5	109,5	57,5
GP2	0070	101	47,5	103,5	53,5
	0095	105	49,5	107,5	55,5
	0113	108	51	110,5	57
	0140	112	53	114,5	59
	0158	115	54,5	117,5	60,5
	0178	118	56	120,5	62
	0208	123	58,5	125,5	64,5
	0234	127	60,5	129,5	66,5
0279	134	64	136,5	70	
GP3	0207	135,5	64	137	71,5
	0225	136,5	64,5	138	72
	0264	139,5	66	141	73,5
	0337	144,5	68,5	146	76
	0394	148,5	70,5	150	78
	0427	151,5	72	153	79,5
	0514	157,5	75	159	82,5
	0600	163,5	78	165	85,5
	0696	170,5	81,5	172	89
	0776	175,5	84	177	91,5
0876	181,5	87	183	94,5	

NOTE: Add 11 mm to both A and B quotes on assembled multiple pumps made by GP3+GP1 pumps to calculate the correct overall.

16 - CONNECTION FLANGES

dimensions in mm

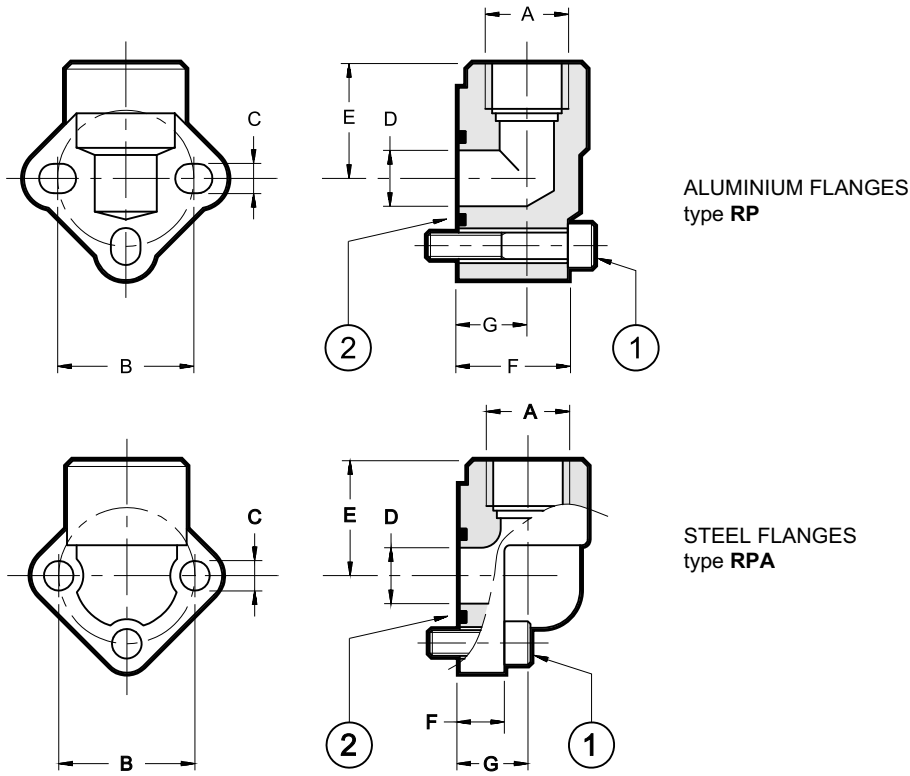

ALUMINIUM FLANGES TYPE RP

Fastening bolt and O-rings included

	Flange code	Flange description	P_{max} [bar]	$\varnothing A$	B	C	$\varnothing D$	E	F	G	(1) SHC bolts	(2) seals
GP1	0610506	RP1 - 38	180	3/8" BSP	30	6.5	12.5	30	26	18	n°3 - M6x35	OR 121 (15.88x2.62)
	0610248	RP1 - 12		1/2" BSP	30	6.5	12.5	30	26	18		
GP2	0610508	RP2 - 12		1/2" BSP	40	8.5	18.5	40	31	20	n°3 - M8x45	OR 130 (22.22x2.62)
	0610249	RP2 - 34		3/4" BSP	40	8.5	18.5	40	31	20		
GP3	0610717	RP3 - 34		3/4" BSP	51	10.5	25	46	43	26	n°3 - M10x60	OR 4118 (29.75x3.53)
	0610250	RP3 - 100		1" BSP	56	10.5	25	46	43	26		

STEEL FLANGES TYPE RPA

	Flange code	Flange description	P_{max} [bar]	$\varnothing A$	B	C	$\varnothing D$	E	F	G	(1) SHC bolts	(2) seals
GP1	0771048	RPA1 - 38	315	3/8" BSP	30	6.5	12	24	17	9.5	n°3 - M6x20	OR 121 (15.88x2.62)
	0771049	RPA1 - 12		1/2" BSP	30	6.5	12	24	17	9.5		
GP2	0771050	RPA2 - 12		1/2" BSP	40	8.5	20	36	22	11.5	n°3 - M8x25	OR 132 (23.81x2.62)
	0770615	RPA2 - 34		3/4" BSP	40	8.5	20	36	22	11.5		
GP3	0771051	RPA3 - 34A		3/4" BSP	51	10.5	24	46	26	13	n°3 - M10x30	OR 3125 (31.42x2.62)
	0770617	RPA3 - 100A		1" BSP	51	10.5	24	46	26	13		
	0770618	RPA3 - 34B	3/4" BSP	56	10.5	24	46	26	13			
	0770619	RPA3 - 100B	1" BSP	56	10.5	24	46	26	13			
	0771052	RPA35 - 114A	1" 1/4 BSP	62	13	31	55	35	17	n°3 - M10x35		