

DS2

SOLENOID OPERATED DIRECTIONAL CONTROL VALVE

SERIES 10

SUBPLATE MOUNTING ISO 4401-02

p max 350 bar
Q max 25 l/min

MOUNTING INTERFACE

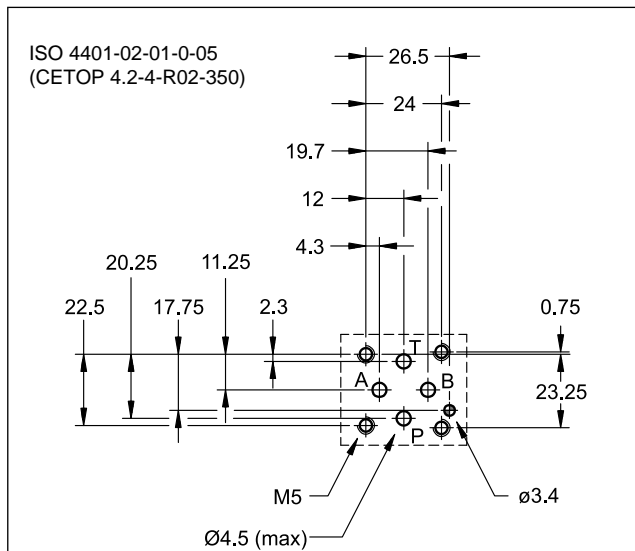

OPERATING PRINCIPLE

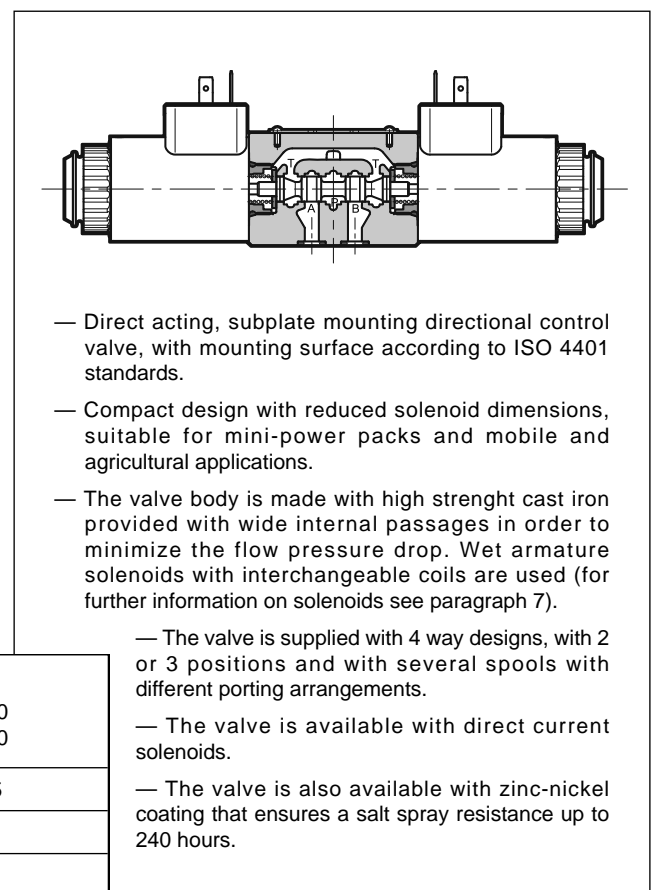

PERFORMANCES

(obtained with mineral oil with viscosity of 36 cSt at 50°C)

Maximum operating pressure: - ports P - A - B - port T	bar	350 250
Maximum flow rate	l/min	25
Pressure drop $\Delta p-Q$	see paragraph 4	
Operating limits	see paragraph 5	
Electrical features	see paragraph 7	
Electrical connections	EN 175301-803 (ex DIN 43650)	
Ambient temperature range	°C	-20 / +50
Fluid temperature range	°C	-20 / +80
Fluid viscosity range	cSt	10 ÷ 400
Fluid contamination degree	According to ISO 4406:1999 class 20/18/15	
Recommended viscosity	cSt	25
Mass: single solenoid valve double solenoid valve	kg	0.9 1.3

1 - IDENTIFICATION CODE

	D	S	2	-	/	10	-	K1	/	
--	----------	----------	----------	---	---	-----------	---	-----------	---	--

Directional valve, solenoid operated

ISO 4401-02 size

Spool type (see paragraph 2)

S* TA RK
SA* TB
SB*

Series: _____
(the overall and mounting dimensions remain unchanged from 10 to 19)

Seals: _____
N = NBR seals for mineral oil (**standard**)
V = FPM seals for special fluids

NOTE 2: The standard valve is supplied with surface treatment of phosphating black.
The zinc-nickel finishing on the valve body makes the valve suitable to ensure a salt spray resistance up to **240** hours (test operated according to UNI EN ISO 9227 standards and test evaluation operated according to UNI EN ISO 10289 standards).

Option:
/ W7 = Zinc-nickel surface treatment (see **NOTE 2**)
Omit if not required

Manual override:
Omit for override integrated in the tube (**standard**)
CM = manual override, boot protected
CK1 = turning knob override

Coil electrical connection (see par. 11):
K1 = plug for connector type EN 175301-803 (ex DIN 43650) (**standard**)
K2 = plug for connector type AMP JUNIOR
K7 = plug DEUTSCH DT04-2P for male connector type DEUTSCH DT06-2S

Power supply
D12 = 12 V
D24 = 24 V
D00 = valve without coils (see **NOTE 1**)

NOTE 1: coils locking ring and related OR are supplied together with valves.

2 - SPOOL TYPE

<p>Type S*: 2 solenoids - 3 positions with spring centering</p> <p>S1 S2 S3 S4</p>	<p>Type SA*: 1 solenoid side A 2 positions (central + external) with spring centering</p> <p>SA1 SA2 SA3 SA4</p>	<p>Type SB*: 1 solenoid side B 2 positions (central + external) with spring centering</p> <p>SB1 SB2 SB3 SB4</p>
<p>Type RK: 2 solenoids - 2 positions with mechanical retention</p> <p>RK</p>	<p>Type TA: 1 solenoid side A 2 external positions with spring return</p> <p>TA</p>	<p>Type TB: 1 solenoid side B 2 external positions with spring return</p> <p>TB</p>

3 - HYDRAULIC FLUIDS

Use mineral oil-based hydraulic fluids HL or HM type, according to ISO 6743-4. For these fluids, use NBR seals (code N). For fluids HFDR type (phosphate esters) use FPM seals (code V). For the use of other fluid types such as HFA, HFB, HFC, please consult our technical department.

Using fluids at temperatures higher than 80 °C causes a faster degradation of the fluid and of the seals characteristics. The fluid must be preserved in its physical and chemical characteristics.

4 - PRESSURE DROPS $\Delta P-Q$

(obtained with viscosity 36 cSt at 50 °C)

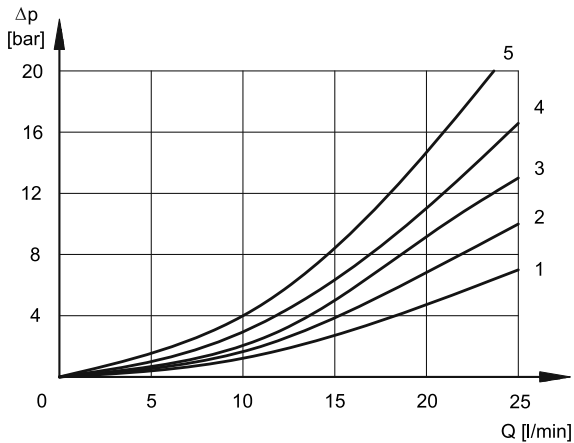

ENERGIZED VALVE

SPOOL	FLOW DIRECTIONS			
	P→A	P→B	A→T	B→T
	CURVES ON GRAPHS			
S1, SA1, SB1	1	1	2	2
S2, SA2, SB2	1	1	2	2
S3, SA3, SB3	1	1	1	1
S4, SA4, SB4	4	4	5	5
TA	2	1	2	3
RK	1	1	2	2

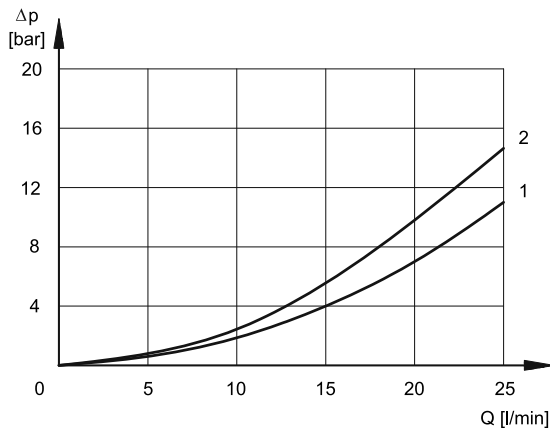

SOLENOID VALVE CENTRAL POSITION

SPOOL	FLOW DIRECTIONS				
	P→A	P→B	A→T	B→T	P→T
	CURVES ON GRAPHS				
S2	-	-	-	-	1
S3	-	-	2	2	-
S4	-	-	-	-	2

5 - OPERATING LIMITS

The curves define the flow rate operating fields according to the valve pressure of the different versions. The operating limits can be considerably reduced if a 4-way valve is used as 3-way valve with port A or B plugged or without flow.

The values have been obtained according to ISO 6403 norm with solenoids at rated temperature and supplied with voltage equal to 90% of the nominal voltage. The value have been obtained with mineral oil, viscosity 36 cSt, temperature 50 °C and filtration according to ISO 4406:1999 class 18/16/13.

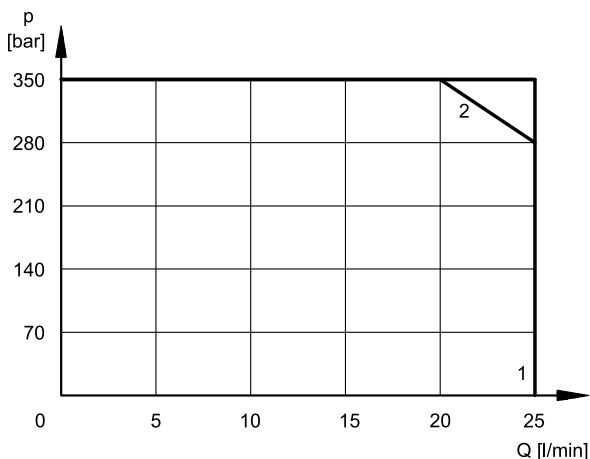

SPOOL	CURVE
S1, S2, S3, TA, TB, RK	1
S4	2

6 - SWITCHING TIMES

The values indicated are obtained according to ISO 6403 standard, with mineral oil viscosity 36 cSt at 50°C.

TIMES ($\pm 10\%$) [ms]	
ENERGIZING	DE-ENERGIZING
25 ÷ 75	15 ÷ 25

7 - ELECTRICAL FEATURES

7.1 - Solenoids

These are essentially made up of two parts: tube and coil. The tube is threaded into the valve body and includes the armature that moves immersed in oil, without wear.

The inner part, in contact with the oil in the return line, ensures heat dissipation. The interchangeability of coils of different voltages is allowed within the same type of supply current, alternating or direct.

The coil is fastened to the tube by a threaded ring, and can be rotated 360°, to suit the available space.

Protection from atmospheric agents IEC 60529

The IP protection degree is guaranteed only with both valve and connectors of an equivalent IP degree, correctly connected and installed.

electric connection	electric connection protection	whole valve protection
K1 EN 175301-803 (ex DIN 43650)	IP65	IP65
K2 AMP JUNIOR	IP65/IP67	
K7 DEUTSCH DT04 male	IP65/IP67	

7.2 - Current and power consumption

In direct current energizing, current consumption stays at fairly constant values, essentially determined by Ohm's law: $V = R \times I$

The table shows current and power consumption values related to coil types.

(values $\pm 10\%$)

	Resistance at 20°C [Ω]	Current consumption [A]	Power consumption [W]	Coil code		
				K1	K2	K7
D12	4.98	2.41	28.9	1903560	1903640	1903650
D24	21	1.15	28	1903561	1903641	1903651

8 - ELECTRIC CONNECTORS

The solenoid valves are not supplied with connector. Connectors type EN 175301-803 (ex DIN 43650) for K1 connections can be ordered separately. For the identification of the connector type to be ordered, please see catalogue 49 000.

9 - INSTALLATION

The valves can be mounted in any position.

Valve fitting takes place by means of screws or tie rods, fixing the valve on a lapped surface, with values of planarity and smoothness that are equal to or better than those indicated in the drawing.

If the minimum values of planarity or smoothness are not met, fluid leakages between valve and mounting surface can easily occur.

SUPPLY VOLTAGE FLUCTUATION	$\pm 10\%$ Vnom
MAX SWITCH ON FREQUENCY	10.000 ins/hr
DUTY CYCLE	100%
ELECTROMAGNETIC COMPATIBILITY (EMC)(NOTE)	In compliance with 2014/30/EU
LOW VOLTAGE	In compliance with 2014/35/EU
CLASS OF PROTECTION: Coil insulation (VDE 0580) Impregnation	class H class F

NOTE: In order to further reduce the emissions, use of type H connectors is recommended. These prevent voltage peaks on opening of the coil supply electrical circuit (see cat. 49 000).

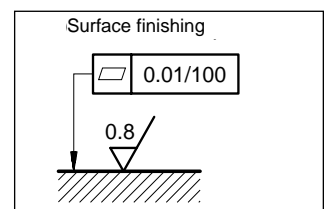

10 - OVERALL MOUNTING AND DIMENSIONS

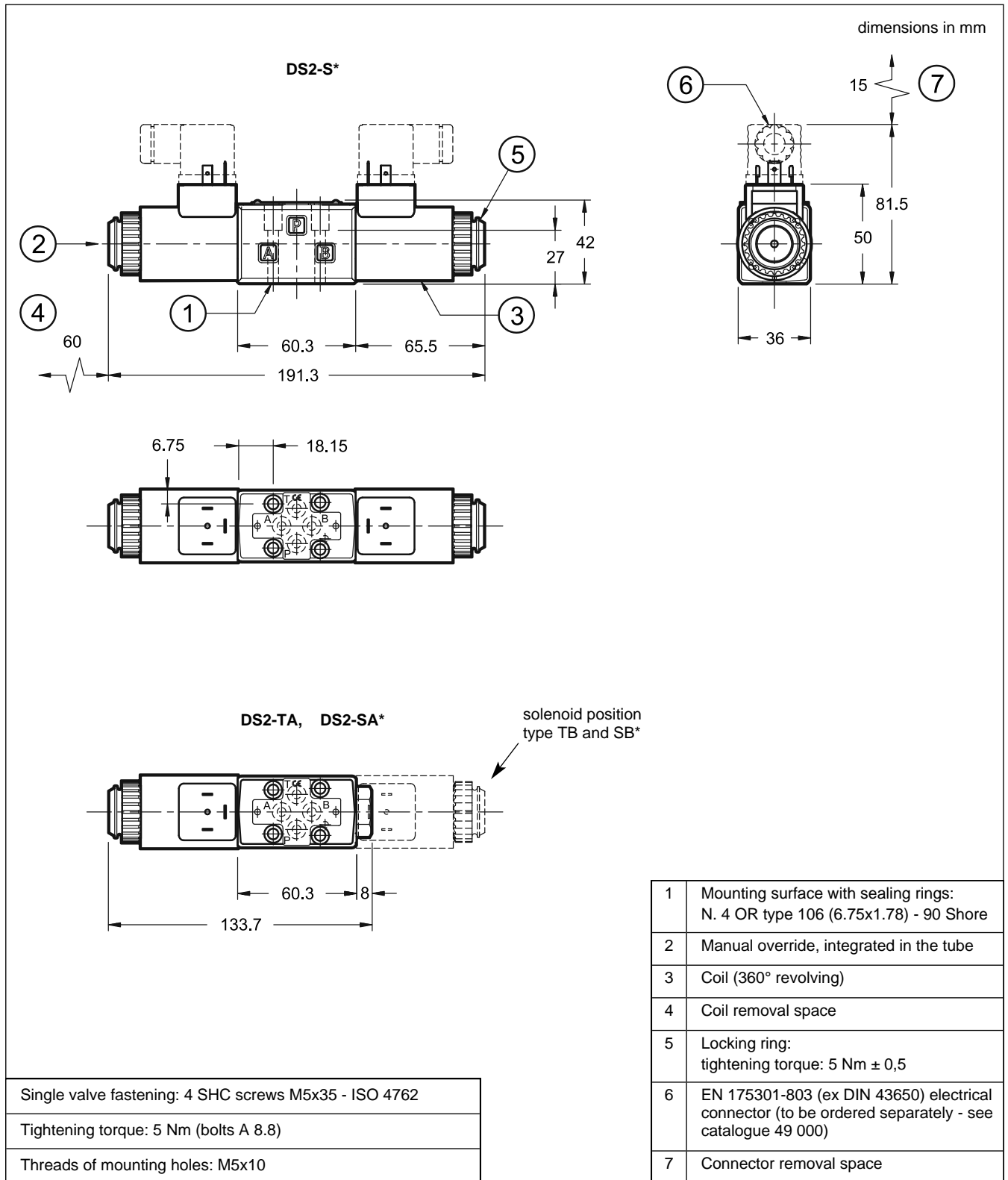

11 - MANUAL OVERRIDES

11.1 - CM - boot protected manual override

The boot override can be ordered by entering the code **CM** in the identification code at par. 1, or is available as option to be ordered separately.

Code: **3404100043**

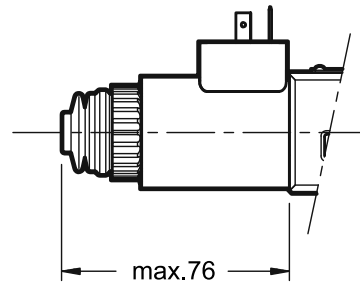

11.2 - Knob manual override

The knob override can be ordered by entering the code **CK1** in the identification code at par. 1, or is available as option to be ordered separately.

Code: **3404100041**

