



# PZME3

## PROPORTIONAL THREE-PORT PRESSURE REDUCING VALVE PILOT OPERATED

### SERIES 10

**MODULAR VERSION  
ISO 4401-03**

**p** max **320** bar  
**Q** max (see table of performances)

#### MOUNTING SURFACE

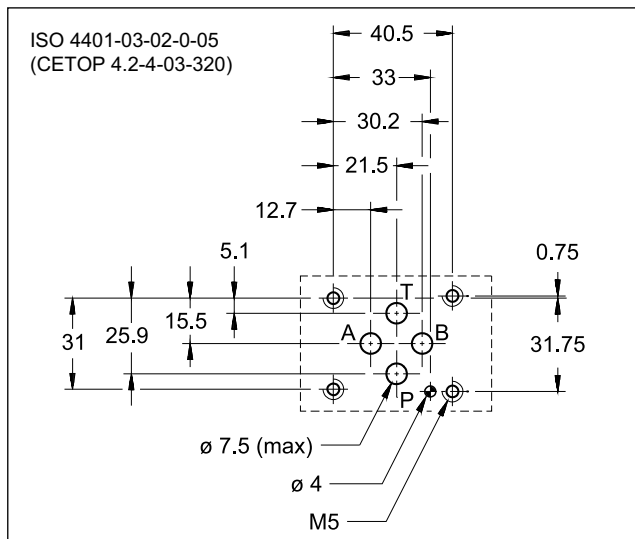

#### OPERATING PRINCIPLE

- PZME3 valves are three-port pressure reducing valves, pilot operated, with proportional control. They are designed in modular version with mounting interface in compliance with ISO 4401-03 standards.
- These valves reduce pressure in the secondary branches of the circuit thus ensuring stability of controlled pressure in the event of variations in the flow rate through the valve.
- The valve can be controlled directly by a current control supply unit or by an electronic control card, to maximize the valve performance (see point. 9).
- The PZME3 valve is available in three pressure control ranges of up to 230 bar.

#### PERFORMANCES

(obtained with mineral oil with viscosity of 36 cSt at 50°C and electronic control card)

Maximum operating pressure: - P-A-B ports - T port	bar	320 2
Minimum controlled pressure	see $\Delta p$ -Q diagram	
Maximum flow in P line	l/min	40
Maximum flow on free flow paths		50
Drain flow		0,4
Step response	see point 6	
Hysteresis (with PWM 200 Hz)	% of p nom	< 3%
Repeatability	% of p nom	< $\pm 1,5\%$
Electrical characteristic	see point 5	
Ambient temperature range	°C	-20 / +60
Fluid temperature range	°C	-20 / +80
Fluid viscosity range	cSt	10 ÷ 400
Fluid contamination degree	According to ISO 4406:1999 class 18/16/13	
Recommended viscosity	cSt	25
Mass	kg	1.5

#### HYDRAULIC SYMBOL

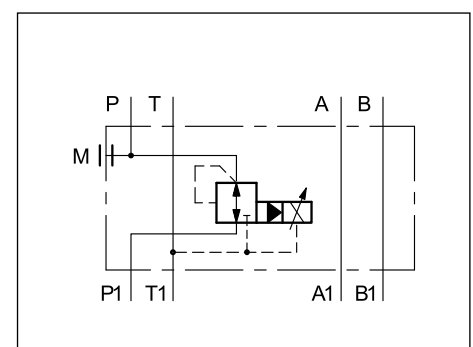

## 1 - IDENTIFICATION CODE

	<b>PZ</b>	<b>M</b>	<b>E</b>	<b>3</b>	<b>-</b>		<b>/</b>	<b>10</b>	<b>-</b>			<b>/</b>	
--	-----------	----------	----------	----------	----------	--	----------	-----------	----------	--	--	----------	--

Three-port pressure reducing valve

Modular version

Electrical proportional control

Size: ISO 4401-03

Pressure control range  
**070** = from 5 to 70 bar      **230** = from 6 to 230 bar  
**150** = from 5.5 to 150 bar

Series No. \_\_\_\_\_  
 (from 10 to 19 sizes and mounting dimensions remain unchanged)

Option: manual override (see point 9)

Coil electrical connection:  
**K1** = plug for connector type EN 175301-803 (ex DIN 43650) (**standard**)  
**K2** = plug for connector type AMP JUNIOR  
**K7** = plug for connector type DEUTSCH DT04-2P male

**D12** = Nominal solenoid voltage 12 V DC  
**D24** = Nominal solenoid voltage 24 V DC

Seals:  
**N** = NBR seals for mineral oil (**standard**)  
**V** = FPM seals for special fluids

## 2 - CHARACTERISTIC CURVES

(measured with viscosity 36 cSt at 50 °C)

**PRESSURE CONTROL  $p = f(I)$**

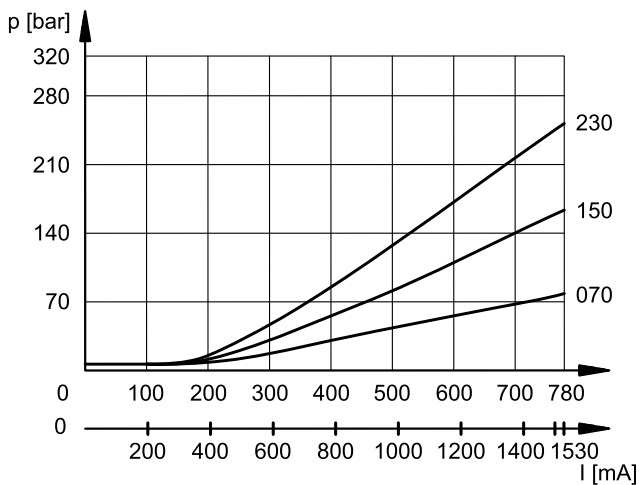

The curves have been obtained with working lines closed (without flow).

**PRESSURE VARIATION  $p = f(Q)$**

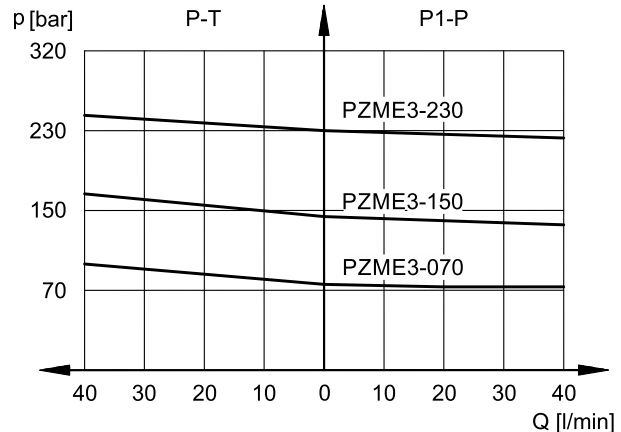

The curves have been obtained with inlet pressure 50 bar greater than nominal pressure.

Pressure values in P1 greater than 50 bar reduce flow values considerably.

**PRESSURE DROP  $\Delta p = f(Q)$**

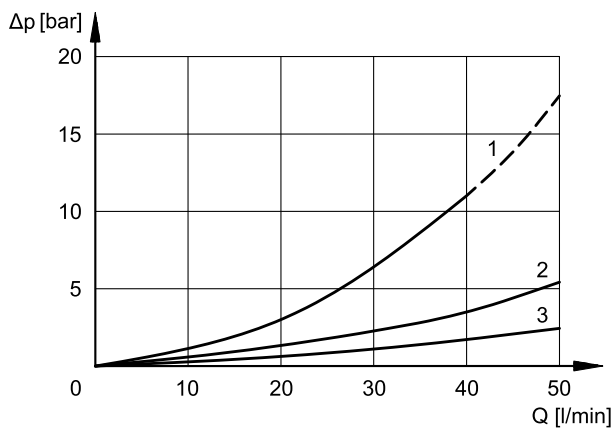

1. pressure drops P1 → P
2. pressure drop in passing lines (ex. A ↔ A1)
3. pressure drops T 1 → T

### 3 - MAX PRESSURE VALUES

This valve incorporates a mechanical limit of the maximum pressure, that operates independently of the applied current. This kind of design ensures that the pressure cannot rise over even if the solenoid current exceeds the maximum current ( $I > I_{max}$ ).

Values obtained with oil viscosity of 36 cSt at 50°C. Values obtained with working lines closed (without flow).

		PZME3-070	PZME3-150	PZME3-230
pressure value at 780 mA	bar	75	155	240
max pressure value when $I > I_{max}$	bar	95	185	260

### 4 - HYDRAULIC FLUIDS

Use mineral oil-based hydraulic fluids HL or HM type, according to ISO 6743-4. For these fluids, use NBR seals.

For fluids HFDR type (phosphate esters) use FPM seals (code V).

For the use of other fluid types such as HFA, HFB, HFC, please consult our technical department.

Using fluids at temperatures higher than 80 °C causes a faster degradation of the fluid and of the seals characteristics.

The fluid must be preserved in its physical and chemical characteristics.

### 5 - ELECTRICAL CHARACTERISTICS

The proportional solenoid comprises two parts: tube and coil.

The tube, screwed to the valve body, contains the armature which is designed to maintain friction to a minimum thereby reducing hysteresis.

The coil is mounted on the tube and is secured by means of a lock nut. It can be rotated through 360° depending on installation clearances.

#### Protection from atmospheric agents IEC 60529

The IP protection degree is guaranteed only with both valve and connectors of an equivalent IP degree correctly connected and installed.

electric connection	electric connection protection	whole valve protection
K1	IP65	IP65
K2	IP65	
K7	IP65/67	

<b>NOMINAL VOLTAGE</b>	V DC	<b>12</b>	<b>24</b>
<b>RESISTANCE (at 20°C)</b>	Ω	4.98	21
<b>NOMINAL CURRENT</b>	A	1.53	0.78
<b>DUTY CYCLE</b>		100%	
<b>ELECTROMAGNETIC COMPATIBILITY (EMC)</b>	According to 2014/30/EU		
<b>CLASS OF PROTECTION</b> Coil insulation (VDE 0580) Impregnation	class H class F		

### 6 - STEP RESPONSE

(obtained with mineral oil with viscosity of 36 cSt at 50 °C and electronic control card)

Step response is the time taken for the valve to reach 90% of the set pressure value following a step change of reference signal.

The table illustrates typical step response times measured with input flow rate of  $Q = 25$  l/min.

REFERENCE SIGNAL STEP	0 → 100%	100 → 0%
Step response [ms]	60	60

### 7 - INSTALLATION

These valves can be installed in any position without impairing correct operation if it is ensured that there is no air in the hydraulic circuit. Otherwise, vertical mounting with solenoid downward is preferable. In this case you must consider possible variations of the minimum controlled pressure values reported in point 2. Connect the valve T port directly to the reservoir.

Add any return pressure value detected in the T line to the reduced pressure value.

**NOTE: Occurring return pressures are to be added up to the value of pressure setting at T port.**

Valves are fixed by means of screws or tie rods on a flat surface with planarity and roughness equal to or better than those indicated in the relative symbols. If minimum values are not observed fluid can easily leak between the valve and support surface.

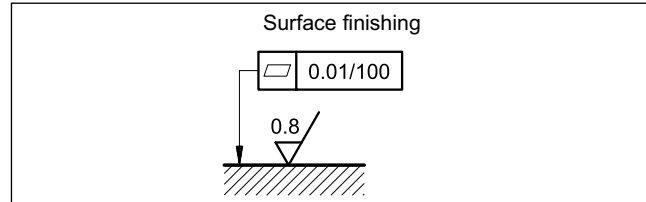

### 8 - OVERALL AND MOUNTING DIMENSIONS

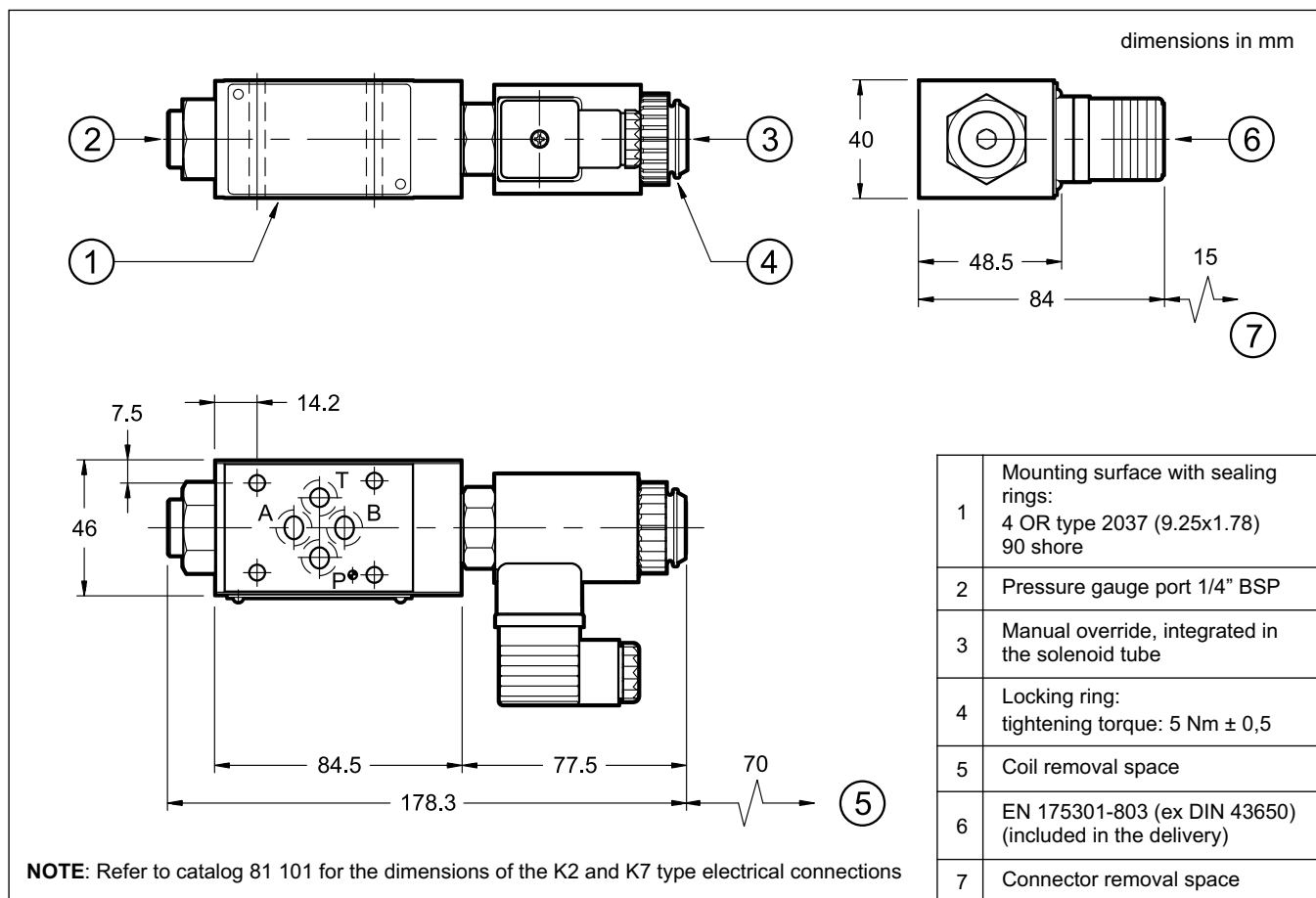

### 9 - MANUAL OVERRIDE

These valves have solenoids whose pin for manual operation is integrated in the tube. Actuate this override by pushing it with a suitable tool, minding not to damage the sliding surface. Two different manual override versions are available upon request: **CM** version, manual override boot protected, and **CK1** version, knob to screw.

For more information about these manual overrides, see the catalogue 81 101.

### 10 - ELECTRONIC CONTROL UNITS

<b>EDM-M102</b>	24V DC solenoids	rail mounting	see cat.
<b>EDM-M163</b>	12V DC solenoids	DIN EN 50022	89 251