



DSE3B

DIRECTIONAL VALVE WITH PROPORTIONAL CONTROL SERIES 10

SUBPLATE MOUNTING ISO 4401-03

p max 350 bar
Q max 40 l/min

MOUNTING INTERFACE

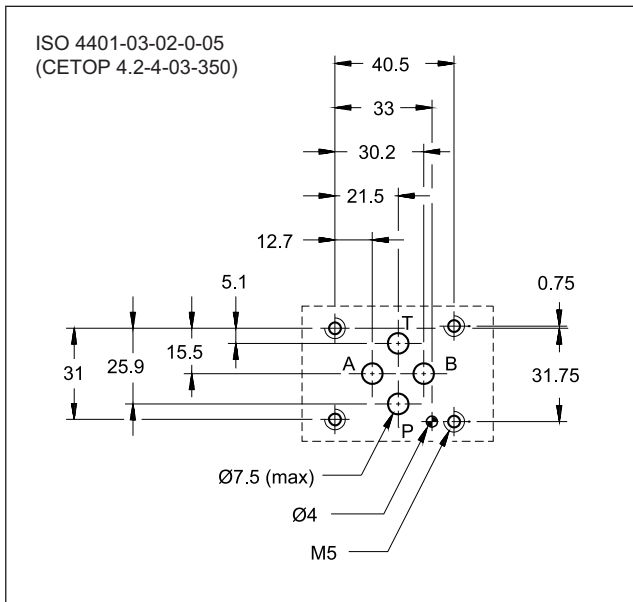

OPERATING PRINCIPLE

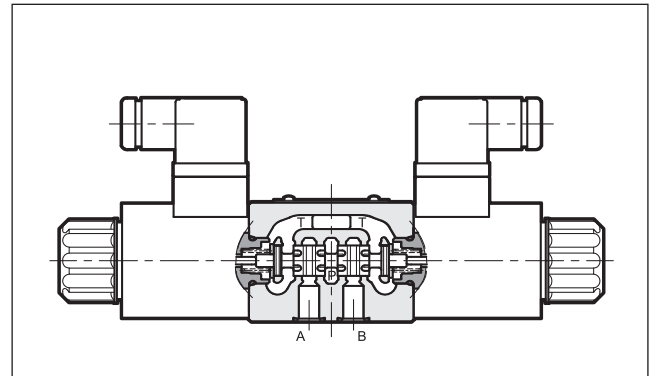

- The DSE3B valve is a direct operated directional valve with electric proportional control, with ports in compliance with ISO 4401-03 standards.
- It is suitable for directional and speed control of hydraulic actuators.
- Valve opening and hence flow rate can be modulated continuously in proportion to the current supplied to the solenoid.
- The valve can be controlled directly by a current control supply unit or combined with an external electronic card to exploit valve performance to the full (see par. 12).

PERFORMANCES

(obtained with mineral oil with viscosity of 36 cSt at 50°C and electronic control card)

Max operating pressure: P - A - B ports T port	bar	350 160
Nominal flow with Δp 10 bar P-T	l/min	1 - 4 - 8 - 16 - 26
Step response		see chapter 5
Hysteresis (with PWM 200 Hz)	% Q max	< 6%
Repeatability	% Q max	< \pm 2%
Electrical characteristics		see chapter 4
Ambient temperature range	°C	-20 / +60
Fluid temperature range	°C	-20 / +80
Fluid viscosity range	cSt	10 \div 400
Fluid contamination degree	According to ISO 4406:1999 class 18/16/13	
Recommended viscosity	cSt	25
Mass: single solenoid valve double solenoid valve	kg	1.6 2.0

HYDRAULIC SYMBOLS (typical)

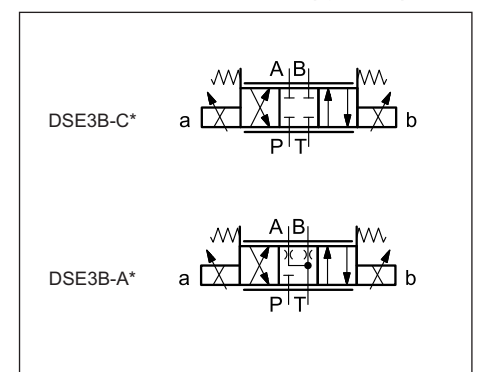

1 - IDENTIFICATION CODE

D	S	E	3	B	-				/ 10	-		/	
---	---	---	---	---	---	--	--	--	------	---	--	---	--

Direct operated directional valve

Electric proportional control

Size ISO 4401-03

Spool type:
C = closed centres
A = open centres

Spool nominal flow (see paragraph 2)

Solenoid position (omit for configuration with two solenoids):
SA = 1 solenoid on side A
SB = 1 solenoid on side B

Option:
/ W7 = Zinc-nickel surface treatment (see **NOTE**)
 Omit if not required

Option: manual override (see at par. 8)

Coil electrical connection:
K1 = plug for connector type EN 175301-803 (ex DIN 43650) (**standard**)
K7 = plug DEUTSCH DT04-2P for male connector type DEUTSCH DT06-2S

D12 = Nominal solenoid voltage 12V DC
D24 = Nominal solenoid voltage 24V DC

Seals:
N = NBR seals for mineral oil (**standard**)
V = FPM seals for special fluids

Series No.
 (from 10 to 19 sizes and mounting dimensions remain unchanged)

NOTE: The standard valve is supplied with surface treatment of phosphating black. The zinc-nickel finishing on the valve body makes the valve suitable to ensure a salt spray resistance up to **240** hours. For a salt spray resistance up to **600** hours refer to **paragraph 9**. (test operated according to UNI EN ISO 9227 standards and test evaluation operated according to UNI EN ISO 10289 standards).

2 - CONFIGURATIONS

Valve configuration depends on the combination of the following elements:
 number of proportional solenoids, spool type, nominal flow rate.

2 solenoids configuration:
 3 positions with spring centring

“SA” configuration: 1 solenoid on side A.
 2 positions (central + external) with spring centring

“SB” configuration: 1 solenoid on side B.
 2 positions (central + external) with spring centring

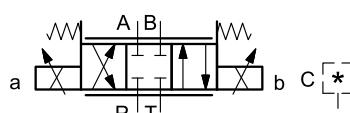
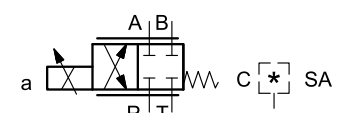
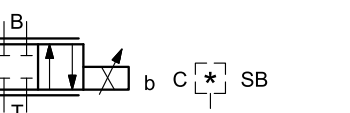
* Controlled flow with Δp 10 bar P-T

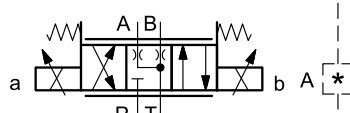
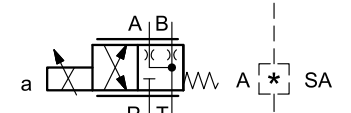
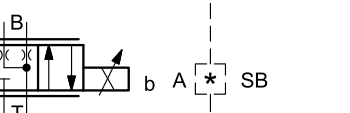
*	Controlled flow with Δp 10 bar P-T
01	1 l/min
04	4 l/min
08	8 l/min
16	16 l/min
26	26 l/min

3 - CHARACTERISTIC CURVES

(obtained with mineral oil with viscosity of 36 cSt at 50°C and electronic control card)

Typical constant flow rate control curves at Δp according to current supply to solenoid (D24 version, maximum current 860 mA), measured for the various spool types available.

The reference Δp values are measured between ports P and T on the valve.

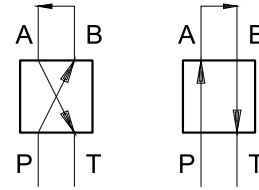

SPOOL TYPE C01/A01

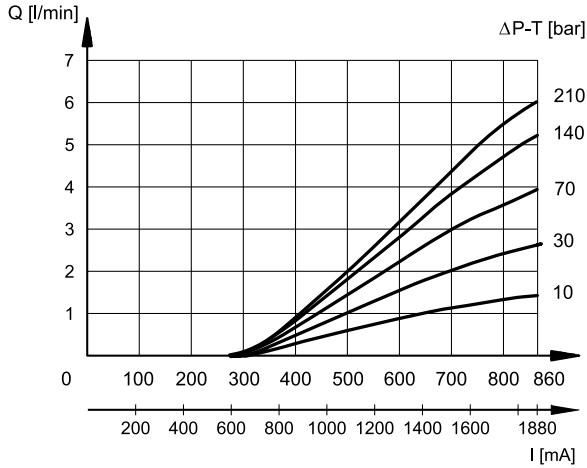

SPOOL TYPE C04/A04

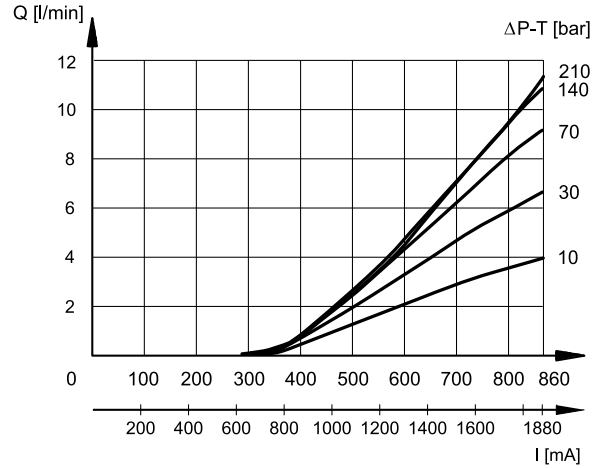

SPOOL TYPE C08/A08

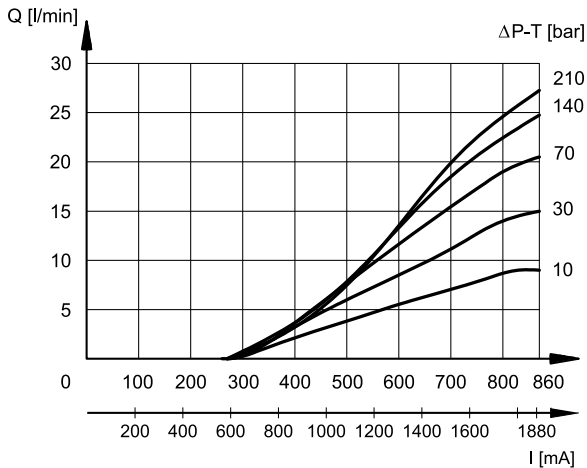

SPOOL TYPE C16/A16

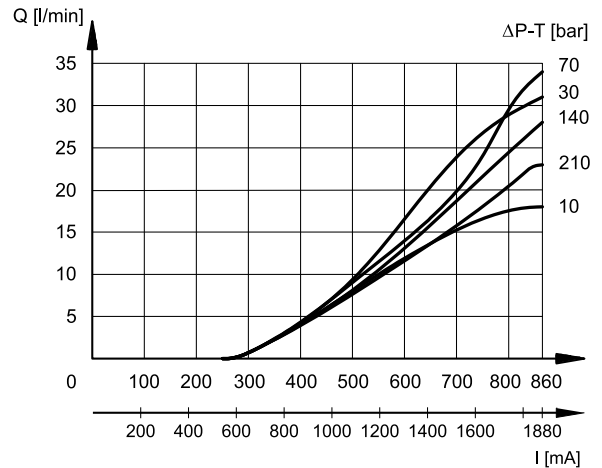

SPOOL TYPE C26/A26

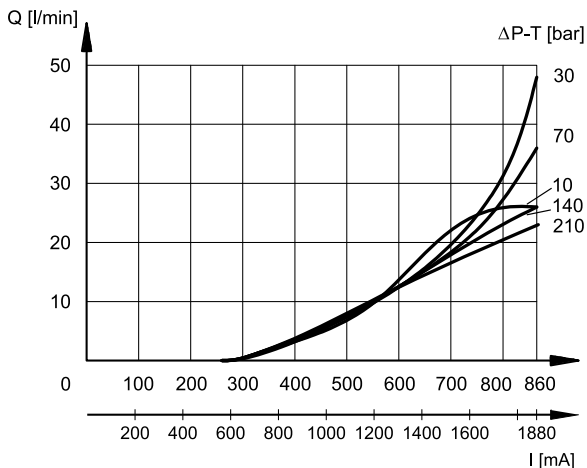

4 - ELECTRICAL CHARACTERISTICS

Proportional solenoid

The proportional solenoid comprises two parts: tube and coil. The tube, screwed to the valve body, contains the armature which is designed to maintain friction to a minimum thereby reducing hysteresis.

The coil is mounted on the tube secured by means of a lock nut. It can be rotated through 360° depending on installation clearances.

NOMINAL VOLTAGE	V DC	12	24
RESISTANCE (at 20°C)	Ω	4,4	18,6
MAXIMUM CURRENT	A	1,88	0,86
DUTY CYCLE	100%		
ELECTROMAGNETIC COMPATIBILITY (EMC)	according to 2014/30/EU		
CLASS OF PROTECTION coil insulation (VDE 0580) impregnation	class H class F		

Protection from atmospheric agents IEC 60529

The IP protection degree is guaranteed only with both valve and connectors of an equivalent IP degree correctly connected and installed.

electric connection	electric connection protection	whole valve protection
K1 EN 175301-803 (ex DIN 43650)	IP65	IP65
K7 DEUTSCH DT04 male	IP65/67	

5 - STEP RESPONSE

(obtained with mineral oil with viscosity of 36 cSt at 50°C and electronic control card)

Step response is the time taken for the valve to reach 90% of the setted positioning value, following a step change of reference signal.

The table shows typical response times tested with spool type C16 and $\Delta p = 30$ bar P-T.

REFERENCE SIGNAL STEP	0 → 100%	100 → 0%
Step response [ms]	50	40

6 - ELECTRIC CONNECTIONS

Connectors for K1 and WK1 connections are always delivered together with the valve.

connection for EN 175301-803 connector
code **K1 (standard)**
code **WK1** (W7 version only)

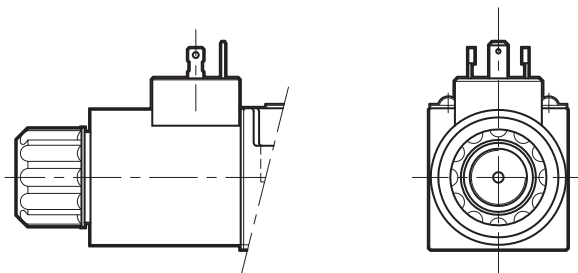

connection for DEUTSCH DT06-2S male connector
code **K7**



connection for DEUTSCH DT06-2S male connector
code **WK7** (W7 version only)

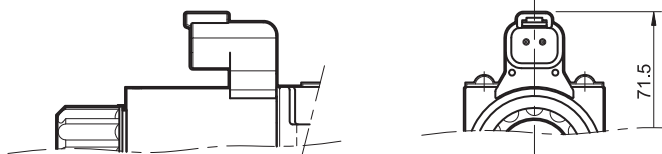

7 - OVERALL AND MOUNTING DIMENSIONS

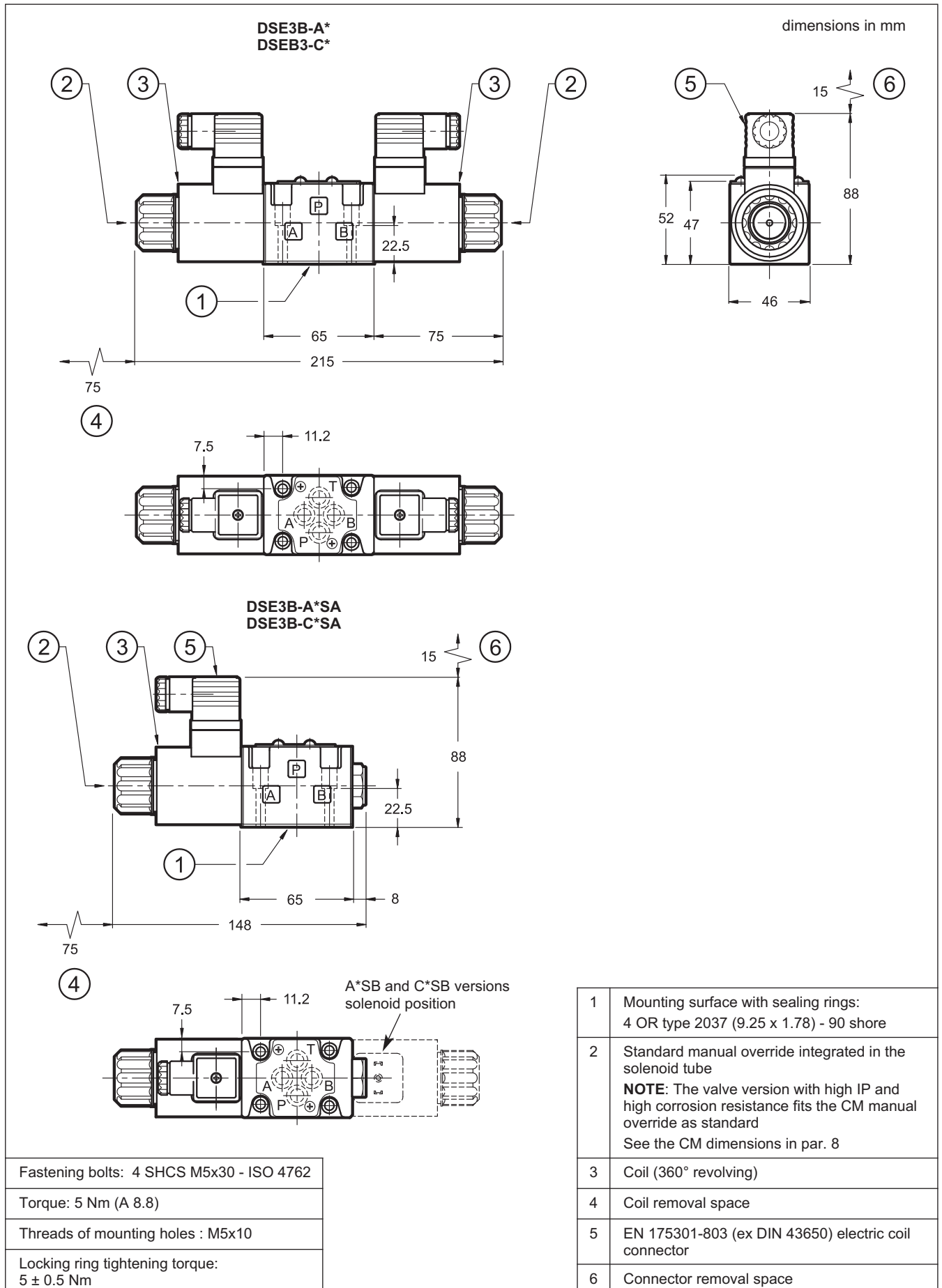

8 - MANUAL OVERRIDE

These valves have solenoids whose pin for manual operation is integrated in the tube. Actuate this override by pushing it with a suitable tool, minding not to damage the sliding surface.

Three different manual override version are available upon request:

- **CM** version, manual override boot protected.
- **CK1** version, turning knob override.
- **CS** version, with metal ring nut provided with a M8 screw and a blocking locknut to allow the continuous mechanical operations.

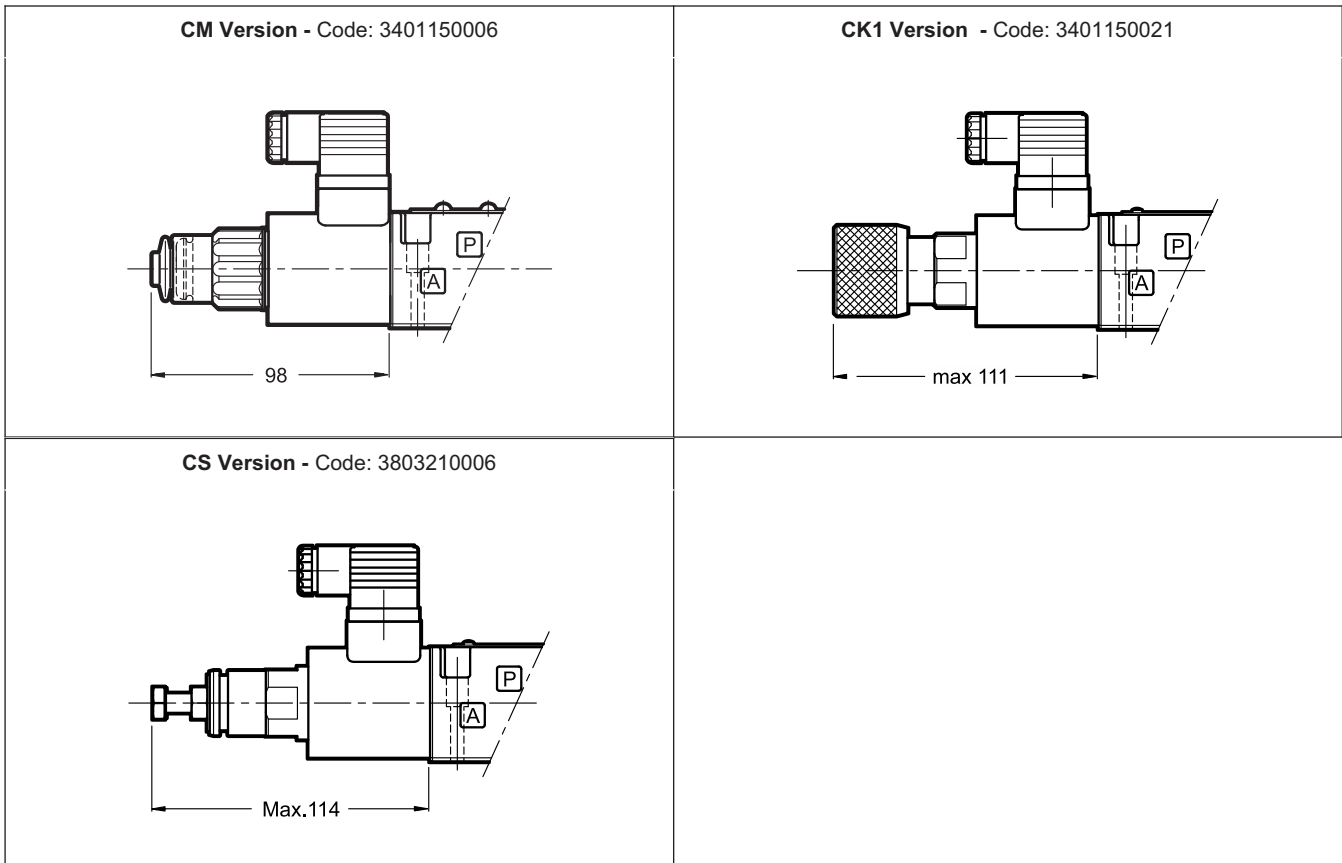

9 - HIGH IP AND CORROSION RESISTANCE VERSION

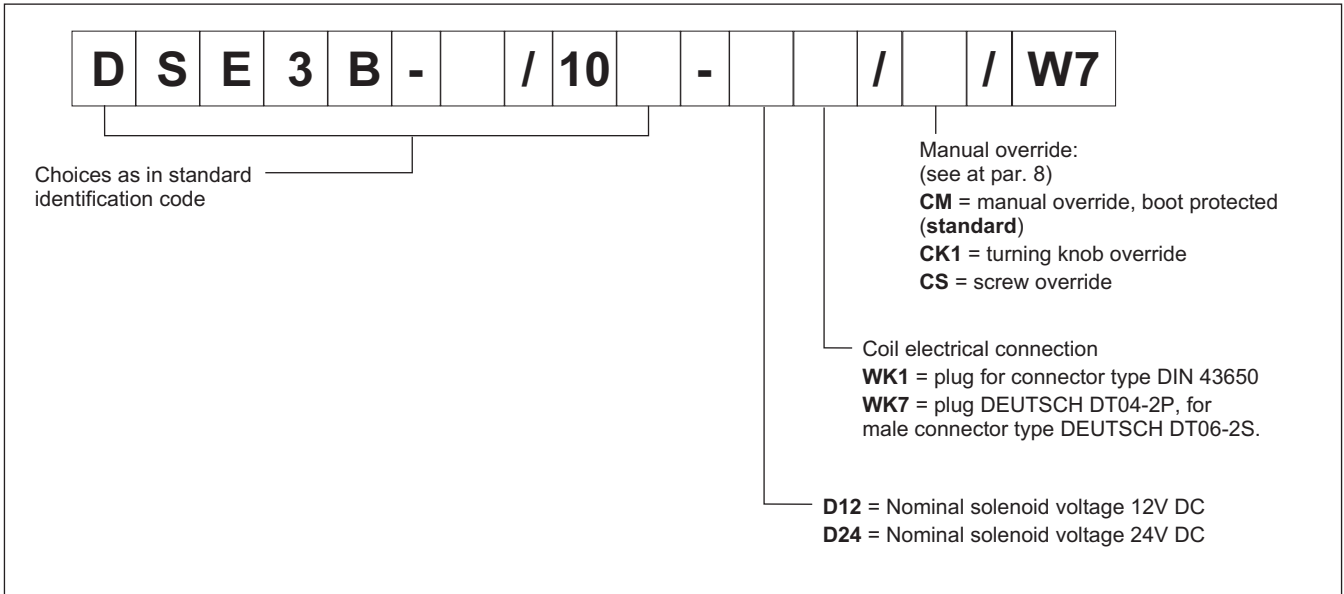

9.1 - Corrosion resistance

This version features the zinc-nickel coating on all exposed metal parts of the valve, making it resistant to exposure to the salt spray for **600** hours (test performed according to UNI EN ISO 9227 and assessment test performed according to UNI EN ISO 10289).

The boot protected manual override is fitted as standard in order to protect the solenoid tube. See the dimensions of the CM manual override in par. 8.

9.2 - Coils

The coils feature a zinc-nickel surface treatment. The electrical characteristics do not change compared to the standard version: see table in par. 4

9.3 - Protection from atmospheric agents IEC 60529

The IP protection degree is guaranteed only with both valve and connectors of an equivalent IP degree correctly connected and installed.

electric connection	electric connection protection	whole valve protection
WK1 EN 175301-803 (ex DIN 43650)	IP66	IP66
WK7 DEUTSCH DT04 male	IP66/IP68/IP69 IP69K*	IP66/IP68/IP69 IP69K*

(*) The IP69K protection degree is not taken into account in IEC 60529 but it is included in ISO 20653.

NOTE: As regards the liquid ingress protection (second digit), there are three means of protection.

Codes from 1 to 6 are related to water jets.

Rates 7 and 8 are related to immersion.

Rate 9 is reserved for high pressure and temperature water jets.

This means that IPX6 covers all the lower steps, rate IPX8 covers IPX7 but not IPX6 and lower, instead IPX9 does not cover any of them.

Whether a device meets two types of protection requirements it must be indicated by listing both the tests separated by a slash.

(E.g. a marking of an equipment covered both by temporary immersion and water jets is IP66/IP68).



10 - HYDRAULIC FLUIDS

Use mineral oil-based hydraulic fluids like HL or HM type, according to ISO 6743-4. With this kind of fluids, use NBR seals type (code N). For HFDR fluids type (phosphate esters) use FPM seals (code V). For use with other kind of fluids such as HFA, HFB, HFC please consult our technical department.

Using fluids at temperatures higher than 80 °C causes a faster degradation of the fluid and of the seals characteristics. The fluid must be preserved in its physical and chemical characteristics.

11 - INSTALLATION

DSE3B valves can be installed in any position without impairing correct operation.

Ensure that there is no air in the hydraulic circuit.

Valves are fixed by means of screws or tie rods on a lapped surface with planarity and roughness equal to or better than those indicated in the symbol.

If minimum values of planarity or smoothness are not observed, fluid leakages between valve and mounting surface can easily occur.

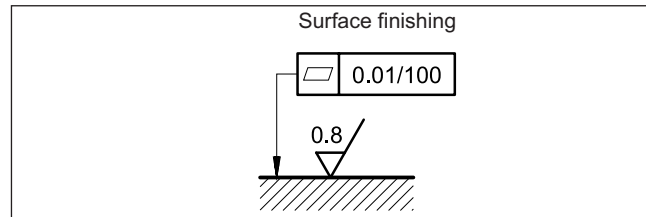

12 - ELECTRONIC CONTROL UNITS

DSE3B - ** SA (SB)

EDC-112	for solenoid 24V DC	plug version	see cat. 89 120
EDC-142	for solenoid 12V DC		
EDM-M112	for solenoid 24V DC	DIN EN 50022 rail mounting	see cat. 89 251
EDM-M142	for solenoid 12V DC		

DSE3B - A* DSE3B - C*

EDM-M212	for solenoids 24V DC	rail mounting DIN EN 50022	see cat. 89 251
EDM-M242	for solenoids 12V DC		

13 - SUBPLATES

(see catalogue 51 000)

Type PMMD-AI3G ports on rear (3/8" BSP threaded)
Type PMMD-AL3G side ports (3/8" BSP threaded)