

# HALFEN

## PUNCHING SHEAR REINFORCEMENT AND SHEAR REINFORCEMENT TECHNICAL PRODUCT INFORMATION



*HALFEN PUNCHING SHEAR REINFORCEMENT  
AND SHEAR REINFORCEMENT*

CONCRETE

HDB 15-E

**NEW!**

FDB II – a new generation of  
punching shear reinforcement

**FILIGRAN**



**HALFEN**  
YOUR BEST CONNECTIONS

# HALFEN PUNCHING SHEAR REINFORCEMENT AND SHEAR REINFORCEMENT

## Contents

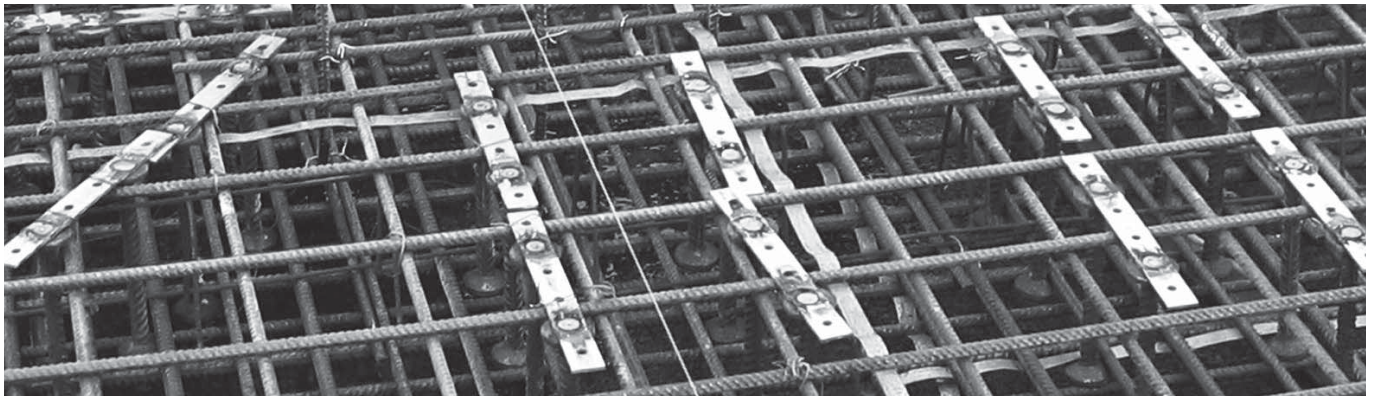

### HALFEN Punching shear and shear reinforcement – general information 3-10

-	Punching shear reinforcement	3
-	HALFEN HDB Shear rail system – system overview	4-5
-	FILIGRAN FDB II Punching shear reinforcement – system overview	6-7
-	HALFEN HDB-S Shear reinforcement – system overview	8-9
-	Product designs HDB/FDB II overview	10



### Design concept PUNCHING SHEAR REINFORCEMENT – HDB/FDB II 11-23

-	Calculation basics	11-17
-	HDB – combination of system elements	18
-	Installation notes HDB/FDB II	19-20
-	Installation notes HDB – according to column geometry	21
-	Type selection – HDB System elements	23



### Design concept SHEAR REINFORCEMENT – HALFEN HDB-S SHEAR RAILS 24-26

-	Calculation table / type selection	22-23
-	Simplified calculation method	24-25
-	Installation notes – allowable anchor spacings	26

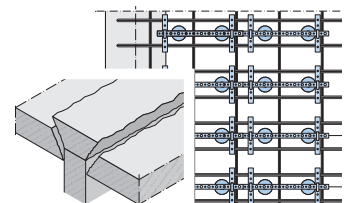

### HALFEN Design software HDB/FDB II/HDB-S 27-29



### Type selection, order information, accessories 30-31

### Tender specifications 32

### References / contacts

-	HALFEN Punching shear and shear reinforcement – references	33
-	Contacts	35

# HALFEN PUNCHING SHEAR REINFORCEMENT

## Punching Shear Reinforcement

### The situation; point-load supported slabs without enlarged column heads

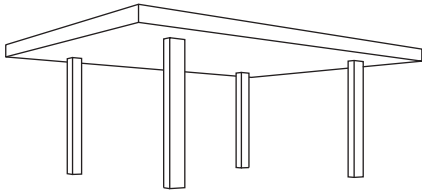

Reinforced concrete slabs with no beams and no enlarged column heads are inexpensive to manufacture. This type of construction results in thinner, lighter and simpler elements, allowing an optimal and flexible use of space.

Particular advantages are:

- low formwork costs
- slimmer, lighter and more aesthetical elements
- easier installation of building utilities under slabs (e.g. pipes or ventilation ducts)
- more flexibility for interior fittings
- floor heights can often be reduced

### The problem: punching shear around columns

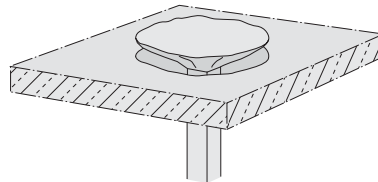

Punching shear of the column head through the concrete slab

Load concentration around the column head generally leads to increased stresses that can't be absorbed solely in thin slab thicknesses.

Previously, to prevent punching shear failure, uneconomical and unfavourable solutions were used, e.g. increasing the slab thickness or using enlarged column heads (see illustration). These methods reduce the usable height between floors and therefore limit building space.

Alternatively, stirrups cages may be used as punching shear reinforcement. However installation is complicated as the stirrups must enclose the longitudinal slab reinforcement.

### – Uneconomical

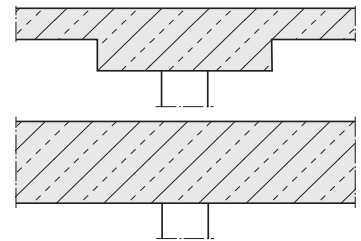

Enlargement of the slab at the column-head (above) or the whole concrete slab (below)

### – Uneconomical

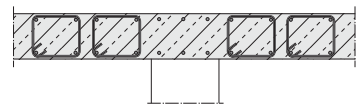

Elaborate and cost intensive installation of stirrup reinforcement cages

### Solution: HALFEN HDB Shear rails



#### Radial installation of HALFEN HDB Shear rails

- for on-site cast slabs, precast slabs and foundations
- high load bearing capacities
- low material requirements
- installation is possible before or after placing the upper and lower layers of reinforcement
- approved as punching shear reinforcement
- suitable for non-predominantly static loads

System description, see page 4 ff

### Solution: FILIGRAN FDB II Punching shear reinforcement

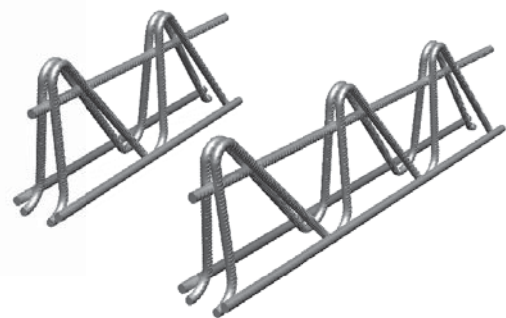

#### Parallel installation of FILIGRAN FDB II Punching shear reinforcement

- for on-site cast slabs or precast slabs
- highest load bearing capacity
- fast installation
- installed after the lower layer of reinforcement but before the upper layer of reinforcement
- approved as punching shear reinforcement

System description, see page 6 ff



# HALFEN HDB SHEAR RAIL – PUNCHING SHEAR REINFORCEMENT

## System Overview

HDB Shear rails are double-headed smooth or ribbed studs with forged heads. The individual studs are welded onto a spacer bar to make a HDB Shear rail.

A main advantage of the HDB Shear rail is the positive-form-locking and nearly slip free anchorage.

HDB Shear rails are ETA approved (ETA, European Technical Approval) for application throughout Europe for static and dynamic loads in standard floor slabs as well as in foundation slabs.



HALFEN HDB Shear rails with clip bars attached

Approvals and further product documents are available for download at [www.halfen.com](http://www.halfen.com)

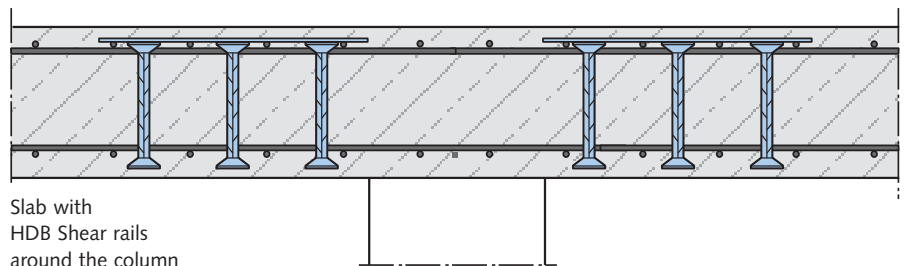

Slab with HDB Shear rails around the column

HALFEN HDB Shear rails are suitable for on-site cast and precast concrete slabs and for use in foundations.

HALFEN has an easy to use intuitive HALFEN Design software. See pages 27-29 for more information



### Load capacities

Punching shear failure around columns causes large diagonal cracks. The excellent positive-form-locking of the HDB Anchor heads minimises shear cracks. This makes the HDB Anchor heads better suited for use in punching shear application with higher loads than comparable stirrup cage reinforcement.

The illustration on the right shows the result of tests proving higher punching shear capability in shear rails compared with stirrup cage reinforcement.

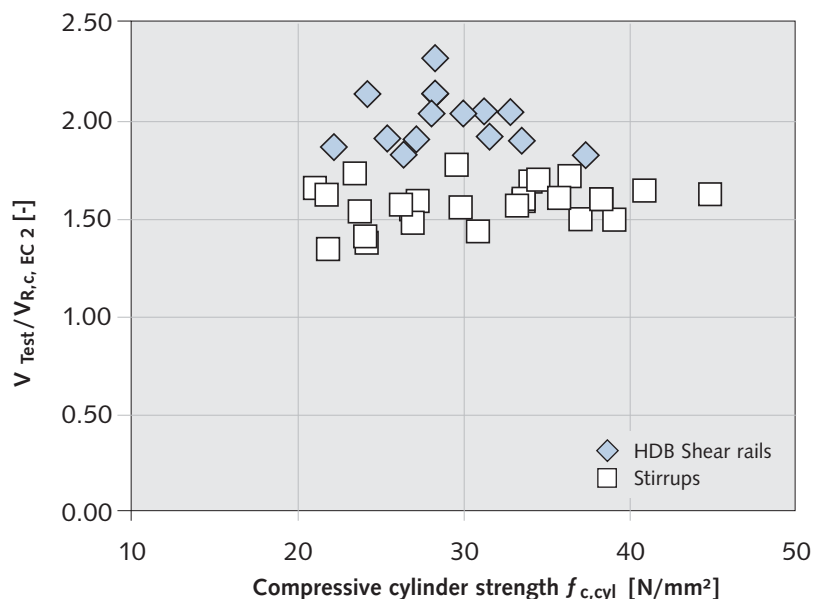

# HALFEN HDB SHEAR RAIL – PUNCHING SHEAR REINFORCEMENT

## System Overview

### Advantages of HDB Shear rails

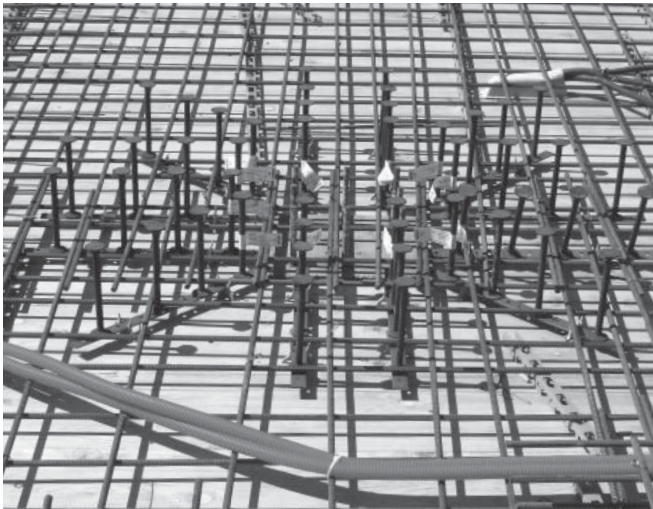

#### ⊕ Planning:

- higher loads in comparison to reinforcement stirrups
- building authority approved as punching shear reinforcement for floor-slabs, foundation slabs and foundation footings
- HDB Shear rails are also suitable for precast or semi-precast slabs
- also approved for non-predominantly static loads
- standardised scope of supply for common types
- powerful and user-friendly software

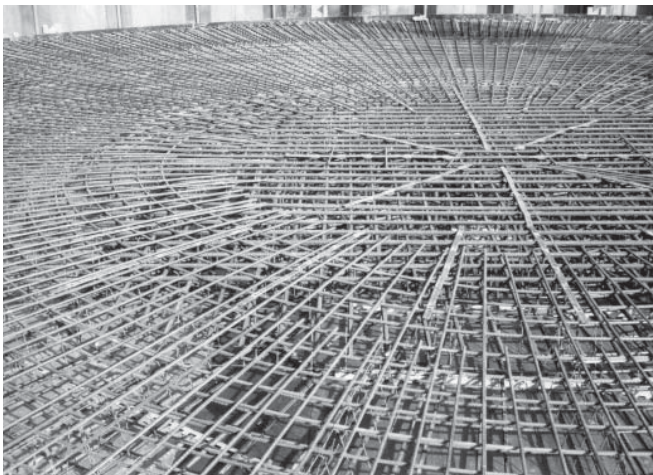

#### ⊕ Safety:

- european-wide building authority approved (ETA-12/0454) by the German Institute for building technology DIBt in Berlin (*DIBt Deutsches Institut für Bautechnik*)
- simple visual check of installed elements
- negligible slippage of anchorage in the shear reinforcement
- correct concrete cover ensured with matching accessories (spacers and clamps)



#### ⊕ Installation:

- simple and quick installation
- reduced build-time
- no enclosure of longitudinal reinforcement required
- installation is possible after placing the upper and lower longitudinal reinforcement
- reduction in required punching shear reinforcement through larger approved tangential anchor spacings in comparison with reinforcement stirrups which are in accordance with the – German national annex NA(D) to EN 1992-1-1:2011-01 (Eurocode 2).

# FILIGRAN FDB II PUNCHING SHEAR REINFORCEMENT

## System Overview

The FILIGRAN FDB II is a completely new development in punching shear reinforcement. Suitable for use in on-site cast slabs as well as in semi-precast filigree slabs with lattice girders. The punching shear reinforcement consists of diagonal, ribbed reinforcement struts. The struts are alternately slanted at different angles with loops protruding above the upper reinforcement chord. Anchorage is through these loops via the rigid weld connections to the steel reinforcement bars in the elements.

The main benefit of the FILIGRAN FDB II Punching shear reinforcement is the user friendly installation of the elements; especially in semi-precast filigree slabs with lattice girders.

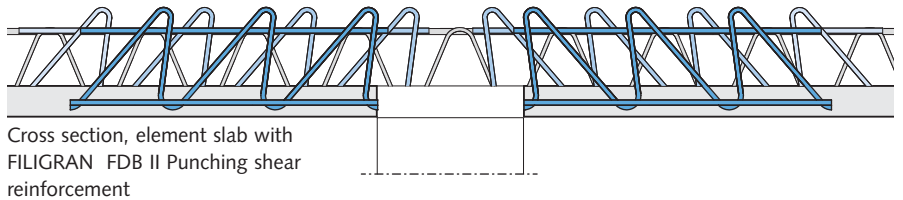
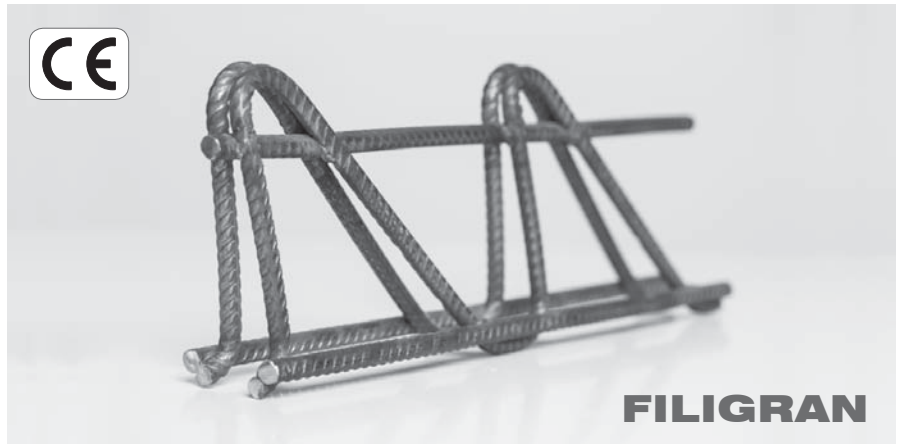

The FILIGRAN FDB II Punching shear reinforcement was awarded an Innovation prize at the "2014 Ulmer Beton-tage", (Concrete trade fair in the city of Ulm, Germany).

A free, user friendly, intuitive calculation software is available for download at [www.halfen.com](http://www.halfen.com)

### European Technical Approval ETA-13/0521

Building component tests according to approved European guidelines form the basis of European Technical Approval ETA-13/0521.

The load increase factor relatively to slabs without punching shear reinforcement acc. to EC 2 is  $\alpha_{FDBII} = 2.09$ . This means an increase of more than twice the punching shear resistance than in slabs without punching shear reinforcement.

Approvals and further information is available for download at [www.halfen.com](http://www.halfen.com)

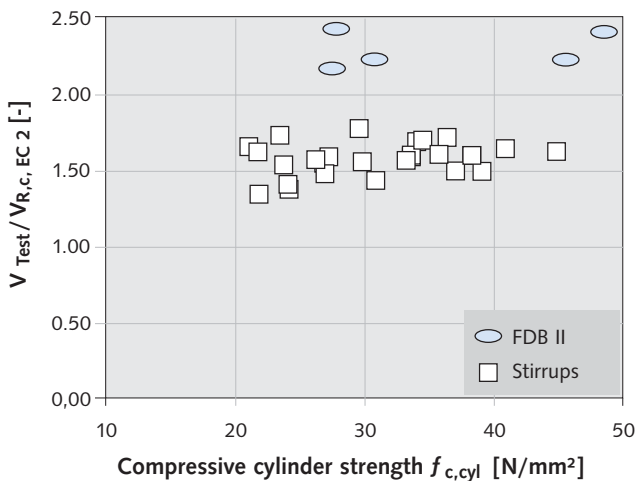

### Load capacities

The load resistance of FDB II Punching shear reinforcement has been determined in component tests at the RWTH Technical university in Aachen. The tests also include the specified conditions in filigree slabs application. Tests were done on filigree slabs with horizontal composite joint, butt joint and with various distances to support columns. The slanting in the load bearing FDB II rebar struts and installation in close proximity to the column guarantee effective dispersal of the punching shear cracks; even when the filigree slabs are installed close or in direct contact to the column. Tests show more than double the punching shear resistance in slabs when using FILIGRAN Punching shear reinforcement.



# FILIGRAN FDB II PUNCHING SHEAR REINFORCEMENT

## System Overview

### Advantages of FDB II Punching shear reinforcement

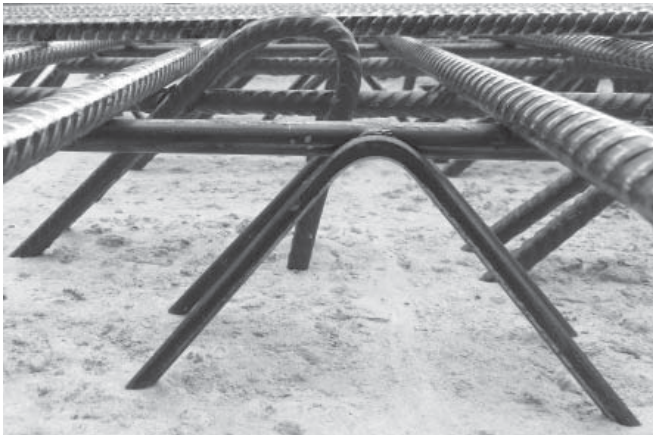

#### ⊕ Planning:

- twice the punching shear resistance, in comparison to slabs without punching shear reinforcement
- european-wide approval (ETA-13/0521) with clear guidelines for filigree slabs
- FDB II regulated as bond reinforcement
- free selection of the slab spacing to the column
- powerful and user-friendly calculation software

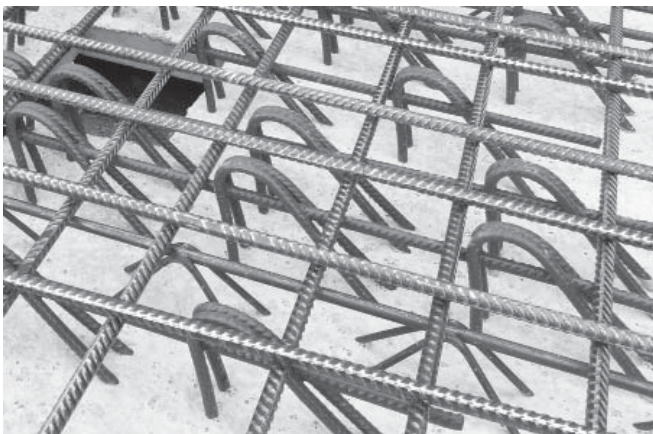

#### ⊕ Safety:

- european-wide approval (ETA-13/0521) issued by the Deutsches Institut für Bautechnik (DIBt) in Berlin
- high safety in planning and application
- good bond between prefabricated slab and on-site cast concrete elements
- application in filigree slabs proved by dedicated building component tests
- non-critical if reinforcement deviates from nominal position

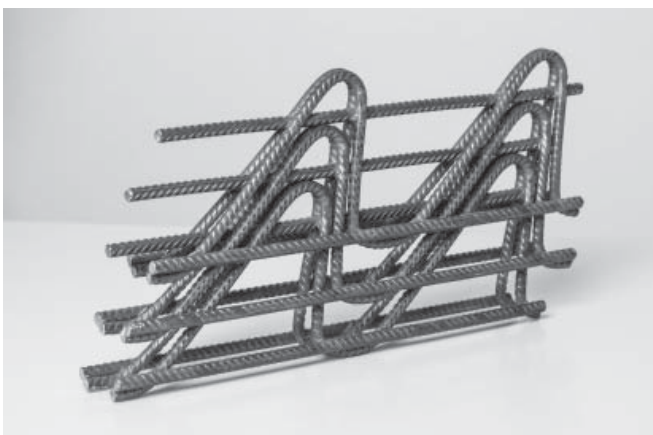

#### ⊕ Installation:

- simple and fast installation in the precast plant
- easy on-site installation
- assembly parallel to the lattice girders
- filigree slabs can be installed close to columns
- rugged construction
- storage with minimum space requirement

# HALFEN HDB-S SHEAR RAIL – SHEAR REINFORCEMENT

## System Overview

### The situation: linear supported slabs – verification of shear load capacity

Shear load capacity for reinforced concrete precast slabs must be verified according to EN 1992-1-1:2011-01 (Eurocode 2) in all shear cross-sections. In Germany, the regulations according to the German National Annex NA(D) must also be observed.

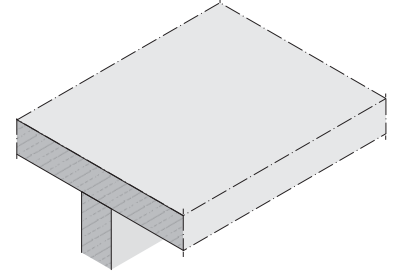
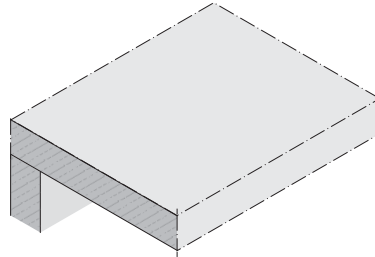

### The problem: shear failure in the support area

Shear forces in the support area of linear supported slabs may cause a brittle shear failure. To avoid shear failure, slab thickness may be increased or shear reinforcement may be installed. However in most cases geometric conditions allow only for installation of shear reinforcement.

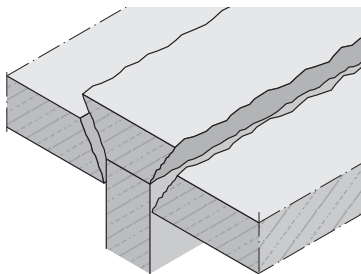

According to the German national annex NA(D) for EN 1992-1-1:2011-01, at least 50 % of expected shear force in high-load slabs\* require stirrup reinforcement, which must enclose the longitudinal reinforcement in the compression zone.

$$*(V_{Ed} > \frac{1}{3} \times V_{Rd,max})$$

Fitting stirrup reinforcement is very demanding as stirrup bending needs to be finalized during installation. This method is not just time-consuming but also inaccurate, resulting in inadequate concrete cover for the stirrups.

#### – Uneconomical:

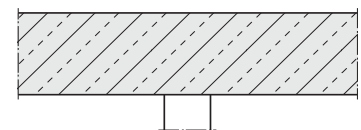

Increasing the slab thickness

#### – Uneconomical:

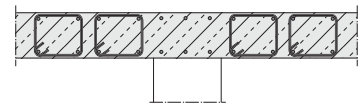

Time consuming installation of stirrup cage reinforcement

### The solution: HALFEN HDB-S Shear rails

HDB-S Shear rails are made of double-headed, forged head anchors. An installation bar tack-welded to the anchor heads connects the individual anchors to form a HDB-S Shear rail. HDB-S Shear rails are preferably placed from above after the main reinforcement has been installed. Placing the individual elements end to end, in rows, allows large areas to be reinforced quickly and efficiently.

A further advantage is the negligible slippage in the concrete, guaranteed by the effective bond of the forged head. This gives the shear reinforcement better anchorage, especially in thin slabs. With HDB-S Anchors the shear reinforcement cross-section is reduced by 20%.

#### + Our solution:

Support with HDB-S Shear reinforcement.

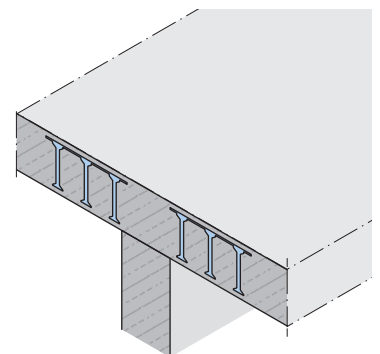



# HALFEN HDB-S SHEAR RAIL – SHEAR REINFORCEMENT

## System Overview

### Advantages of the HDB-S Shear rails



#### ⊕ Planning:

- HDB Shear rails can also be used in precast elements and semi-precast elements
- also approved in Germany for non-predominantly static loads
- standardized product range for typical dimensions
- efficient and user friendly software



#### ⊕ Safety:

- simple visual control of installed elements
- negligible slippage of anchorage in the shear reinforcement
- correct concrete cover is ensured when using suitable accessories (spacers and clamps)
- approved by the German Institute for building technology DIBt in Berlin



#### ⊕ Installation:

- simple and quick installation
- reduced build-time
- longitudinal reinforcement does not need to be tied to the shear reinforcement
- installed after placing the main upper and lower longitudinal reinforcement

# HALFEN PUNCHING SHEAR REINFORCEMENT / SHEAR REINFORCEMENT

## Overview

### HALFEN HDB as punching shear reinforcement and shear reinforcement

#### Double-headed stud

made of reinforcing steel B 500 (smooth or ribbed)  
supplied in diameter  $d_A$ :  
10 - 12 - 14 - 16 - 18 - 20 - 25 mm

The stud head diameter is 3 times the bar diameter  $d_A$ :

$$d_K = 3 \cdot d_A$$

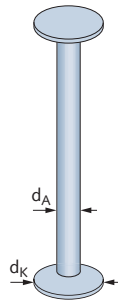

#### HDB/HDB-S Elements

The double-headed studs are connected using a welded-on spacer bar. Clip bars are used to secure the spacer bar to the reinforcement.

Clip bars can be attached anywhere on the spacer bar.

(order separately, see page 31).

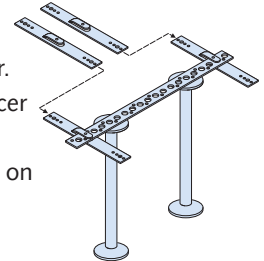

#### Design variants

##### HDB/HDB-S System elements:

- available as 2- and 3-stud elements, can be placed in rows
- standard elements, with short delivery time

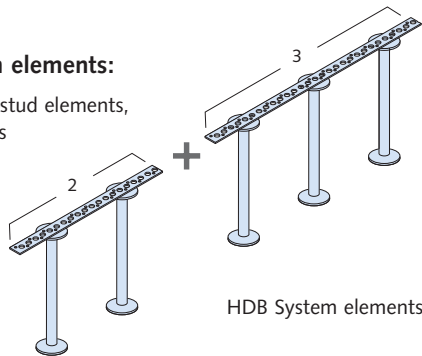

HDB System elements

##### HDB/HDB-S Complete elements

- with 2 - 10 studs on one spacer bar

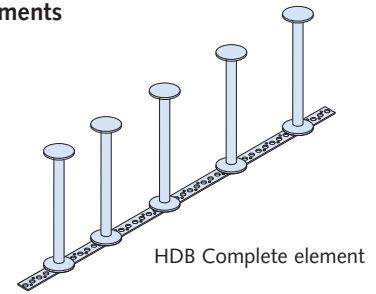

HDB Complete element

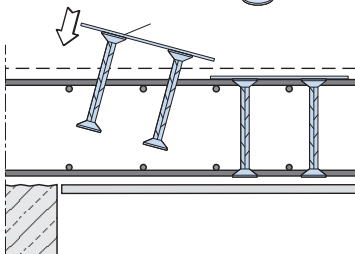

**Symmetrical HDB System elements** are preferably installed from above after installing the main reinforcement.

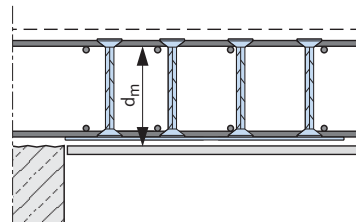

**HDB Complete elements** are preferably installed before placing the main reinforcement

### FILIGRAN FDB II Punching shear reinforcement

#### FILIGRAN FDB II Punching shear reinforcement

Punching shear reinforcement made of ribbed reinforcing steel:

Bar diameter 9 mm (B500A)

Element height from 13 to 30 cm

Top loop projection: 3/4/5/6 cm

① Standard loop for element heights up to 19 cm: 4 cm

Standard loop for element heights greater 20 cm: 5 cm

Element lengths 40/60/80 cm

Standard elements with short delivery time

#### FDB II system description

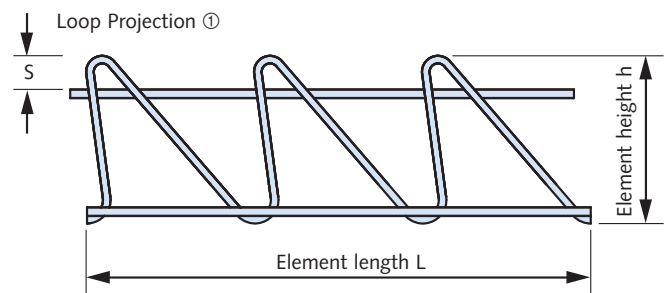

# HALFEN PUNCHING SHEAR REINFORCEMENT

## Calculation: Basic Principles

### Point-load supported slabs

#### Design concept according to EN 1992-1-1:2011-01 (Eurocode 2)

The European standard EN 1992-1-1:2011-01 specifies the maximum punching shear capacity for flat slabs analogically to the strength of the compression strut of beams. However, test evaluations prove that this method is not applicable for flat slabs. Particularly in tests using stirrups as punching shear reinforcement, the level of safety required by EN 1990:2010-12 was not achieved, (see diagram a).

This is why an improved design concept based on current punching shear tests was derived for the HDB Punching shear reinforcement as well as for the FDB II Punching shear reinforcement. The new concept is included in European Technical Approval ETA-12/0454 (HDB) and ETA-13/0521 (FDB II). When using this calculation method, the required level of safety is reached; as shown in the evaluation of the tests using double-headed anchors and FDB II Punching shear reinforcement, (compare diagrams b and c).

European Technical Approvals are issued by the (DIBt) German Institute of Building Technology. ETA-12/0454 regulates design basics for HDB Shear rails and approval ETA-13/0521 design basics for FDB II Punching shear reinforcement.

Deviating from the Eurocode 2 definition, the maximum load capacity was defined as a multiple of the load capacity without punching shear reinforcement. This means the maximum allowable shear stress  $v_{Rd,max}$  is checked along the critical perimeter at a distance of  $2.0d$  from the edge of the load application area. For HDB Shear rails, maximum allowable shear stress must be limited to  $1.96 v_{Rd,c}$  and for FDB II Punching shear reinforcement this must be limited to  $2.09 v_{Rd,c}$ . Here  $v_{Rd,c}$  is the punching shear resistance without punching shear reinforcement calculated in accordance with Eurocode 2 with the respective applicable national annex.

#### a) Stirrups according to EN 1992-1-1:2011-01 without NA(D)

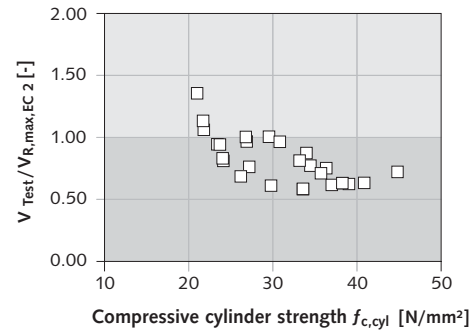

#### b) HDB Shear rails HDB approval ETA-12/0454

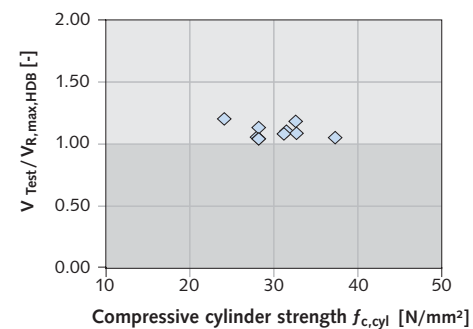

#### c) FDB II Punching shear reinforcement FDB II approval ETA-13/0521

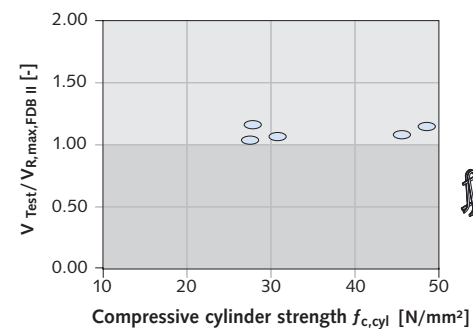



# HALFEN PUNCHING SHEAR REINFORCEMENT

## Calculation: Basic Principles

### Design concept

#### 1. Design concept and actual stresses

$$\text{Design requirement: } \beta \times V_{Ed} \leq V_{Rd}$$

The following constant load factors can be used when calculating the crucial shear force  $\beta \times V_{Ed}$  in accordance with ETA -12/0454 (HDB Shear rails) as well as with ETA-13/ 0521 (FDB II Punching shear reinforcement),

$$\begin{aligned} \beta &= 1.10 && \text{for inner columns (NA(D))} \\ \beta &= 1.15 && \text{for inner columns (EN 1992-1-1)} \\ \beta &= 1.40 && \text{for edge columns} \\ \beta &= 1.50 && \text{for corner columns} \end{aligned}$$

For a quick approximation the following generic, simplified load factors may also be used for wall ends and wall corners:

$$\begin{aligned} \beta &= 1.35 && \text{for wall ends} \\ \beta &= 1.20 && \text{for wall corners} \end{aligned}$$

The more precise method of assuming plastic shear distribution than with EN 1992-1-1:2011-01 can be used as an alternative or as soon as the span width of adjoining slabs deviate more than 25% from one another.

#### 2. Verification of punching shear capacity without punching shear reinforcement

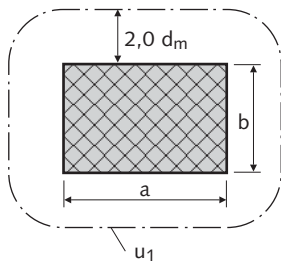

$$u_1 = 2(a + b) + 2 \cdot \pi \cdot 2.0 d_m$$

with:  $b \leq a \leq 2b$   
and  $(a + b) \cdot 2 \leq 12 d_m$   
 $d_m$  = mean effective static depth

Design value for effective shear stress along the critical perimeter:

$$v_{Ed} = \frac{\beta \cdot V_{Ed}}{u_1 \cdot d_m} \quad [\text{N/mm}^2]$$

with:  $\beta$  = load increase factor  
 $V_{Ed}$  = design value of effective shear force  
 $u_1$  = length of the critical perimeter

Design resistance for slabs without punching shear reinforcement:

$$V_{Rd,c} = C_{Rd,c} \cdot k \cdot (100 \cdot \rho_l \cdot f_{ck})^{1/3} \quad [\text{N/mm}^2]$$

The empirical pre-factor  $C_{Rd,c}$  is dependent on the respective column perimeter  $u_0 / d_m$  and is defined as follows:

$$\begin{aligned} u_0 / d_m \geq 4 : C_{Rd,c} &= \frac{0.18}{\gamma_C} \\ u_0 / d_m < 4 : C_{Rd,c} &= \frac{0.18}{\gamma_C} \left( 0.1 \cdot \frac{u_0}{d_m} + 0.6 \right) \geq \frac{0.15}{\gamma_C} \end{aligned}$$

$\gamma_C = 1.5$  : partial safety factor for concrete

$u_0$  = column perimeter

$k = 1 + \sqrt{200/d_m} \leq 2.0$  (Enter scaling factor for influence of the component height in [mm])

$$\rho_l = \sqrt{\rho_{lx} \cdot \rho_{ly}} \leq \begin{cases} 0.02 \\ 0.5 \cdot f_{cd} / f_{yd} \end{cases}$$

(Longitudinal reinforcement ratio in the area of the column width plus  $3d_m$  each side, compare with point 7, page 16)

$f_{ck}$  = characteristic concrete compressive strength [N/mm<sup>2</sup>]

$f_{cd}$  = design value for concrete compressive strength [N/mm<sup>2</sup>]

$f_{yd}$  = design yield strength for reinforcement steel [N/mm<sup>2</sup>]

Verification:  $V_{Ed} \leq V_{Rd,c} \Rightarrow$  no punching shear reinforcement necessary  
 $V_{Ed} > V_{Rd,c} \Rightarrow$  punching shear reinforcement necessary

# HALFEN PUNCHING SHEAR REINFORCEMENT

## Calculation: Basic Principles

### 3. Verification of maximum punching shear capacity

Verification:

$$V_{Ed} \leq V_{Rd,max}$$

For flat slabs:

HDB Shear rails  $V_{Rd,max} = 1.96 V_{Rd,c}$

FDB II Punching shear reinforcement  $V_{Rd,max} = 2.09 V_{Rd,c}$

### 4. Verification outside of the punching shear reinforcement area

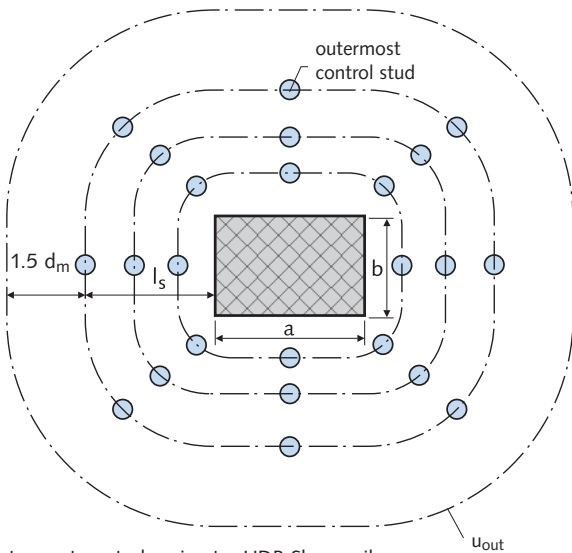

Outermost control perimeter HDB Shear rails

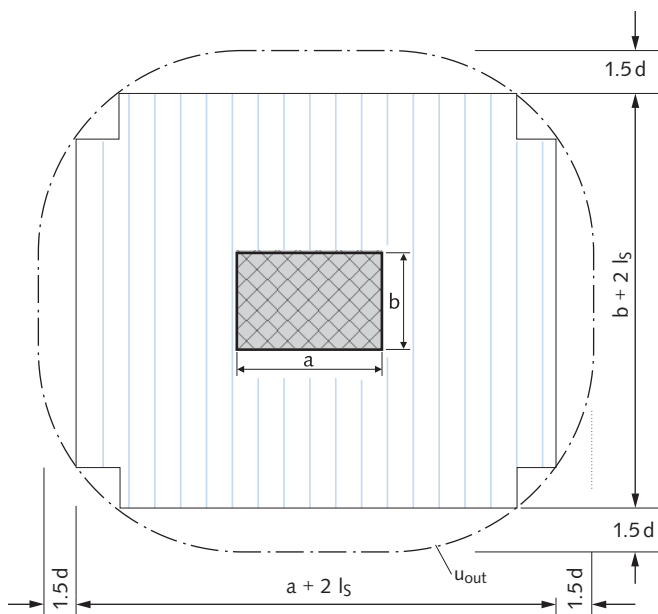

Outermost control perimeter FDB II Punching shear reinforcement

$$u_{out} = 2 \cdot (a + b) + 2\pi \cdot (l_s + 1.5 d_m)$$

with  $l_s$  = distance of the outermost control HDB anchor or the outermost control effective FDB II bar from the column edge

Design value for effective shear stress along the outermost control perimeter:

$$v_{Ed,out} = \frac{\beta_{red} \cdot V_{Ed}}{u_{out} \cdot d_m} \quad [N/mm^2]$$

with  $\beta_{red} = \kappa_\beta \cdot \beta \geq 1.1$   
(e.g. for inner columns,  $\kappa_\beta = 1.0$ )



$\kappa_\beta$ -values for edge and corner columns can be found in approvals ETA-12/0454 and ETA 13/0521.

Calculated resistance along the outermost control perimeter:

$$V_{Rd,c,out} = \frac{0.15}{\gamma_c} \cdot k \cdot (100 \cdot \rho_l \cdot f_{ck})^{1/3} \quad [N/mm^2]$$

Proof:

$$V_{Ed} \leq V_{Rd,c,out} \Rightarrow \text{calculation of } l_{s,req}$$

# HALFEN PUNCHING SHEAR REINFORCEMENT

## Calculation: Basic Principles

### 5. Calculating the required punching shear reinforcement

#### 5.1 HDB Shear rails

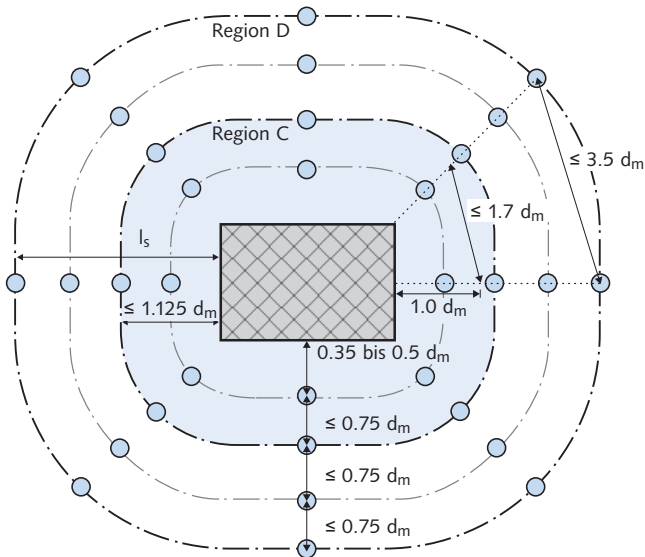

Required punching shear reinforcement in region C

$$A_{s,req} = V_{Ed} \cdot \beta \cdot \eta / f_{yd}$$

with:  $\beta$  = load increase factor

$\eta = 1.0$  for  $d_m \leq 200\text{mm}$  and  $1.6$  for  $d_m \geq 800\text{mm}$   
(interpolate for intermediate values)

Required number of studs  $n_{C,total}$  in region C

$$\text{req } n_{C,total} = A_{s,req} / A_{\text{anchor}}$$

with  $A_{\text{anchor}}$  = cross section of one anchor

Stud layout:

The number of element rows is derived from the geometrical requirements for tangential stud spacing according to the approval (appendix 10, 11 of the ETA-12/0454).

The number of anchors required for region C is calculated according to the approval. See spacing rule for the radial direction. In region C, at least two studs of equal diameter must be used in each element row.

Verification:

$$V_{Rd,sy} = m_C \cdot n_C \cdot A_{\text{anchor}} \cdot f_{yd} / \eta \geq V_{Ed} \cdot \beta \quad [\text{kN}]$$

#### 5.2 FDB II Punching shear reinforcement

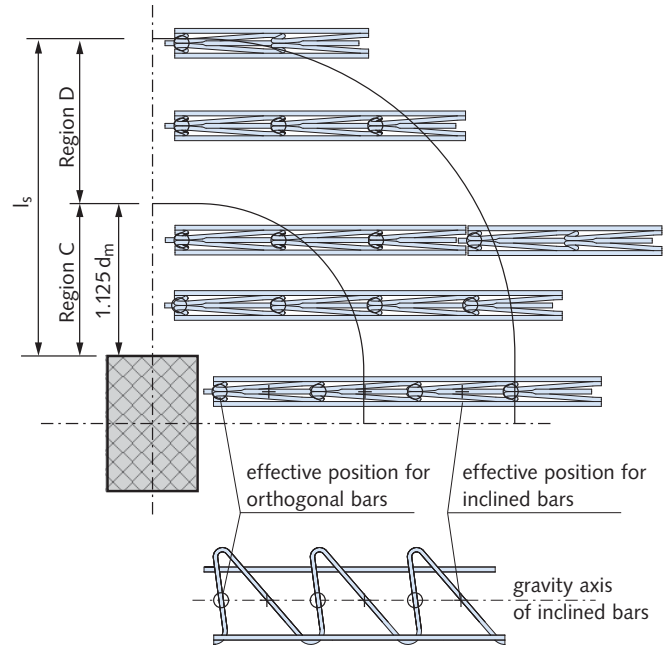

Required Punching shear reinforcement in region C

$$A_{s,req} = V_{Ed} \cdot \beta \cdot \eta / f_{yd}$$

with:  $\beta$  = load increase factor

$\eta = 1.0$  for  $V_{Ed}/V_{Rd,c} = 1.8$

$\eta = 1.5$  for  $V_{Ed}/V_{Rd,c} = 2.09$

(interpolate for intermediate values)

All near perpendicular as well as the diagonal bars orientated directly towards the column may be included when determining the steel load capacity. The positions of the individual bars in plan are assigned to their respective centre of gravity. The force components acting orthogonal to the slab projection of all factored bars are included in the calculation.

$$\beta V_{Ed} \leq V_{Rd,sy} = \frac{f_{yk}}{\gamma_s \cdot \eta} \cdot \sum (A_{sy} \cdot \sin \alpha_i)$$

with:  $A_{sy}$  = cross section surface of a single bar

$\alpha_i$  = respective angle of the effective bars to the slab projection



# HALFEN PUNCHING SHEAR REINFORCEMENT

## Calculation: Basic Principles

### 6. Regulations for spacings

#### 6.1 HDB Shear rails

Apart from the static relevant boundary conditions, further geometric specifications have to be observed when placing studs and elements:

- the distance of the first stud from the column edge must be between  $0.35 d_m$  and  $0.50 d_m$
- maximum studs spacing in radial direction must be  $\leq 0.75 d_m$
- maximum tangential anchors spacing at a distance of  $1.0 d_m$  from the column edge must be  $\leq 1.7 d_m$
- maximum tangential anchor spacing in region D must be  $\leq 3.5 d_m$

For thick slabs ( $d_m > 50 \text{ cm}$ ) with column diameter  $c < 50 \text{ cm}$  with increased load ( $V_{Ed} > 0.85 V_{Rd,max}$ ), at least three studs are to be placed in region C.

The element rows required in region C are to be continued up to the edge of the shear reinforced zone while observing the spacing rules for the section. If necessary, to ensure the tangential spacing required in section D, additional rows of elements must be evenly distributed between the rows continuing out of region C.

In addition, the following applies for the radial spacing  $s_D$  in region D

$$s_D = \frac{3 \cdot d_m}{2 \cdot n_C} \cdot \frac{m_D}{m_C} \leq 0.75 d_m$$

where:

- $m_D$  = number of element rows in region D
- $m_C$  = number of element rows in region C
- $n_C$  = number of anchors in one element row in region C

#### 6.2 FDB II Punching shear reinforcement

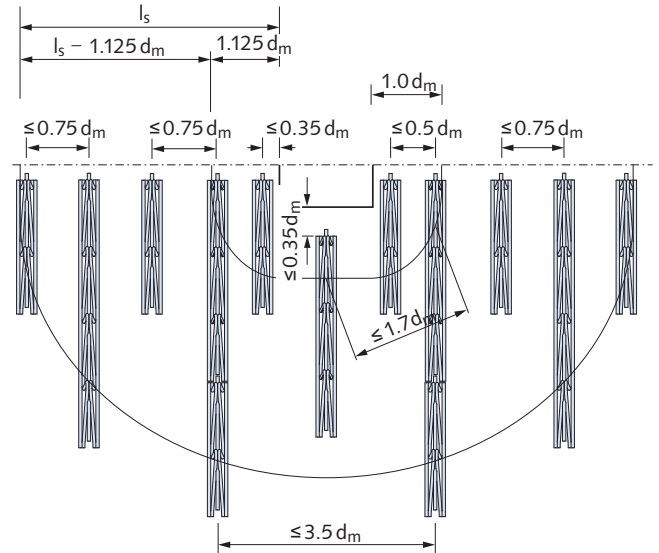

Maximum spacings apply for spacing of reinforcing elements from the column, axial spacings and the spacings in perimetric direction; these are defined as a multiple of the effective static depth. Compliance with these maximum spacings ensures that possible punching shear cracks are dispersed through diagonal bars. This method of reinforcement layout especially the maximum spacings in perimetric direction, ensures an adequate distribution of load among several reinforcement elements.

- maximum diameter of the flexural reinforcement is 25 mm
- spacing to the column face must not exceed  $0.35 d_m$
- within a distance of  $1.0 d_m$  from the column face the tangential spacing of the effective diagonal bars must not exceed  $1.7 d_m$
- at a distance larger than  $1.0 d_m$  from the column face the tangential spacing of the effective diagonal bars must not exceed  $3.5 d_m$
- maximum axial spacing of the FDB II in radial direction must not exceed  $0.75 d_m$

# HALFEN PUNCHING SHEAR REINFORCEMENT

## Calculation: Basic Principles

### 7. Reinforcement ratio

When calculating punching shear, the mean value in the outer perimeter is used as the average ratio of reinforcement. The zone must be at least as wide as the column width with an additional 2-times  $3.0 d_m$  in all directions.

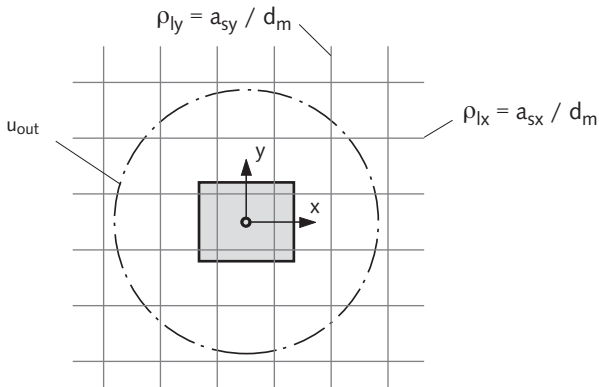

$$\rho_l = \sqrt{\rho_{lx} \cdot \rho_{ly}} \leq \begin{cases} 0.02 \\ 0.5 \cdot f_{cd} / f_{yd} \end{cases}$$

$a_{sx}, a_{sy}$  present flexural reinforcement for each metre in x- and y-direction  
 $d_m$  mean effective static depth

### Minimum bar lengths

#### HDB Shear rails

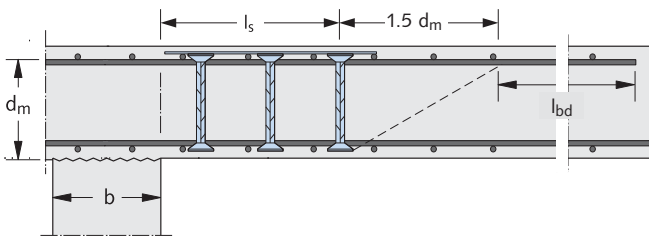

#### FDB II Punching shear reinforcement

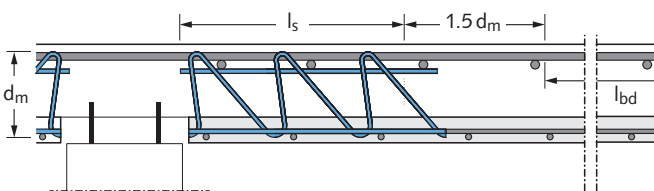

### Minimum bar lengths – example for interior column

$$\begin{aligned} \text{bar length } l_{bar} &= b + 2 \cdot (l_s + 1.5 d_m + l_{bd}) \\ &\geq b + 2 \cdot (3 d_m + l_{bd}) \\ l_{bd} &= \text{anchorage length according to EN 1992-1-1:2011-01 and applicable national annex} \end{aligned}$$

### 8. Allowing for voids and openings

Voids and openings with at least one edge less than  $6 d_m$  away from the load area have to be taken into account when determining the critical perimeter and further perimeters. The section of the critical perimeter within the angle of the opening is to be considered as ineffective.

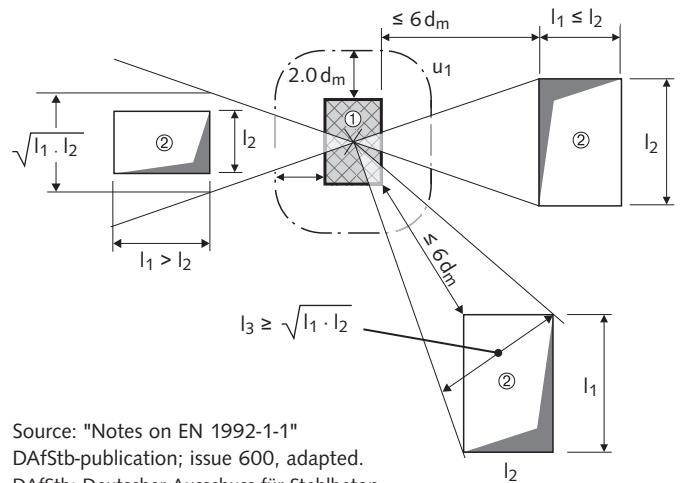

Source: "Notes on EN 1992-1-1"  
 DAFStb-publication; issue 600, adapted.  
 DAFStb; Deutscher Ausschuss für Stahlbeton  
 (German Committee for Structural Concrete)

### Critical perimeter near to openings

Annotation:  
 ① Load application surface  $A_{load}$   
 ② Opening

# HALFEN PUNCHING SHEAR REINFORCEMENT

## Calculation: Basic Principles

### 9. Case 1 – 10

• **Case 1:**  
**Rectangular internal column**

with:  $b \leq a \leq 2b$   
and  $(a + b) \cdot 2 \leq 12 d_m$

$d_m$  = mean effective static depth  
Recommended load factor  $\beta = 1.10$

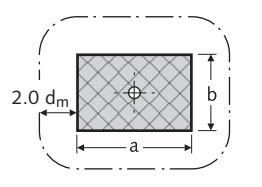

• **Case 6:**  
**Circular edge column**

Recommended load factor  $\beta = 1.4$

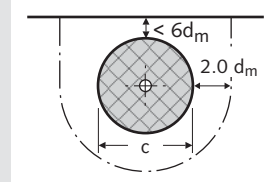

• **Case 2:**  
**Rectangular edge column**  
**Edge parallel to a**

with:  $b \leq a \leq 2b$   
and  $(a + b) \cdot 2 \leq 12 d_m$

Recommended load factor  $\beta = 1.4$

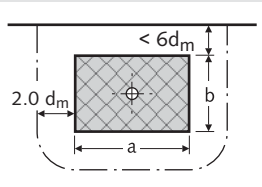

• **Case 7:**  
**Circular corner column**

Recommended load factor  $\beta = 1.5$

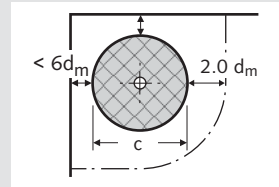

• **Case 3:**  
**Rectangular edge column**  
**Edge parallel to b**

with:  $b \leq a \leq 2b$   
and  $(a + b) \cdot 2 \leq 12 d_m$

Recommended load factor  $\beta = 1.4$

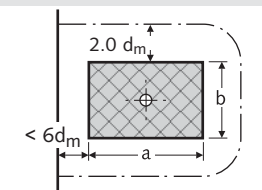

• **Case 8:**  
**Wall corner**

Recommended load factor  $\beta = 1.2$

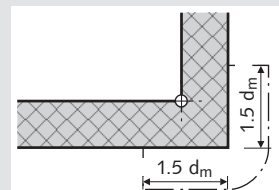

• **Case 4:**  
**Rectangular corner column**  
**Edge parallel to a and b**

with:  $b \leq a \leq 2b$   
and  $(a + b) \cdot 2 \leq 12 d_m$

Recommended load factor  $\beta = 1.5$

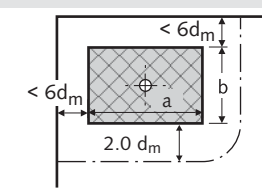

• **Case 9:**  
**Wall end**

Recommended load factor  $\beta = 1.35$

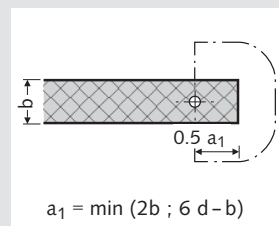

• **Case 5:**  
**Circular inner column**

Recommended load factor  $\beta = 1.10$

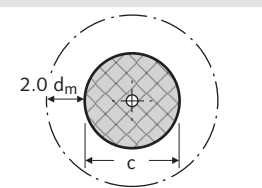

• **Case 10:**  
**Oval inner column**

Recommended load factor  $\beta = 1.10$   
with:  $b \leq 3.5 d$   
and  $b \leq a \leq 2 b$

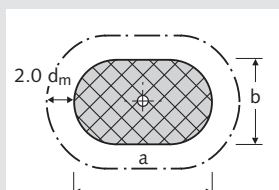



# HALFEN HDB SHEAR RAIL – PUNCHING SHEAR REINFORCEMENT

## Combination of System Elements

### Combinations of HDB System elements

HDB Shear rails in a shear reinforced slab is preferably a combination of 2- and 3-stud system elements. This makes on-site installation easier.

In thick slabs, for example, foundation slabs and where high ratios of reinforcement steel are used, it is recommended to install the HDB Complete elements first, using the bottom-up method.

Table: values  $l_s$  for HDB Element combinations

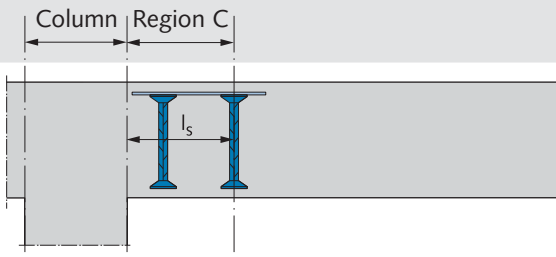
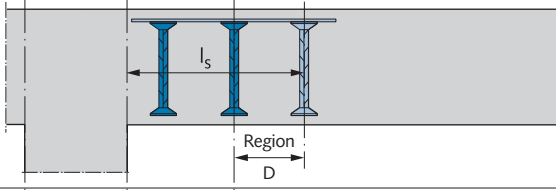
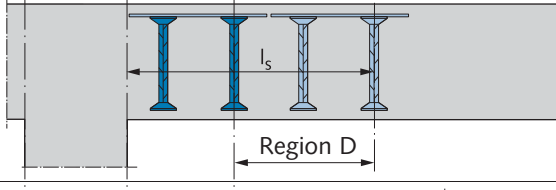
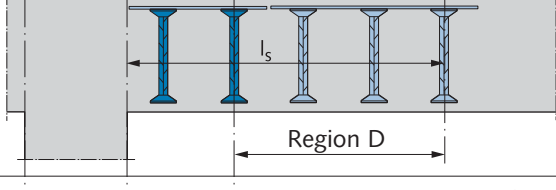
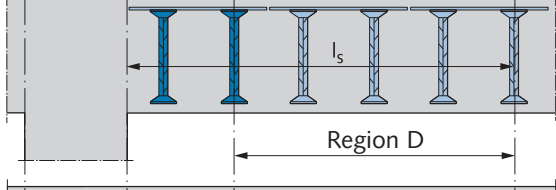
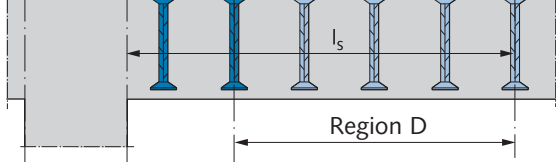
For $l_{s,req}$ (req. $l_s$ ) compare to page 13	Available 2- and 3-stud system HDB combination elements		$l_{s,actual}$	Number of anchors in each HDB combination
$l_{s,req} \leq \sim 1.125 \cdot d_m$	2-stud		$l_{s,actual} \approx 1.05 \cdot d_m$	2
$l_{s,req} \begin{cases} > 1.125 \cdot d_m \\ \leq \sim 1.875 \cdot d_m \end{cases}$	3-stud		$l_{s,actual} \approx 1.75 \cdot d_m$	3
$l_{s,req} \begin{cases} > 1.875 \cdot d_m \\ \leq \sim 2.5 \cdot d_m \end{cases}$	2 + 2 studs		$l_{s,actual} \approx 2.45 \cdot d_m$	4
$l_{s,req} \begin{cases} > 2.5 \cdot d_m \\ \leq \sim 3.2 \cdot d_m \end{cases}$	2 + 3 studs		$l_{s,actual} \approx 3.15 \cdot d_m$	5
$l_{s,req} \begin{cases} > 3.2 \cdot d_m \\ \leq \sim 4.0 \cdot d_m \end{cases}$	2 + 2 + 2 studs		$l_{s,actual} \approx 3.85 \cdot d_m$	6
	3 + 3 studs			

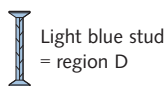
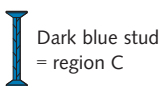

Stud layout  
 $L_A \approx 0.7 \cdot d_m$   
 $L_{\ddot{u}} \approx 0.35 \cdot d_m = L_A/2$

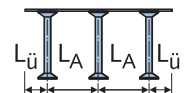

# HALFEN HDB SHEAR RAIL – PUNCHING SHEAR REINFORCEMENT

## Installation Notes

### Layout of the punching shear reinforcement



**Note:**

The simultaneous use of ribbed and smooth studs for the same column is not permitted!

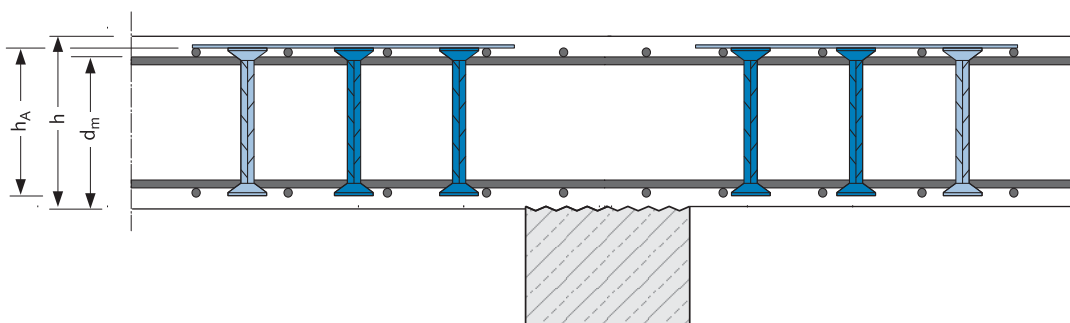
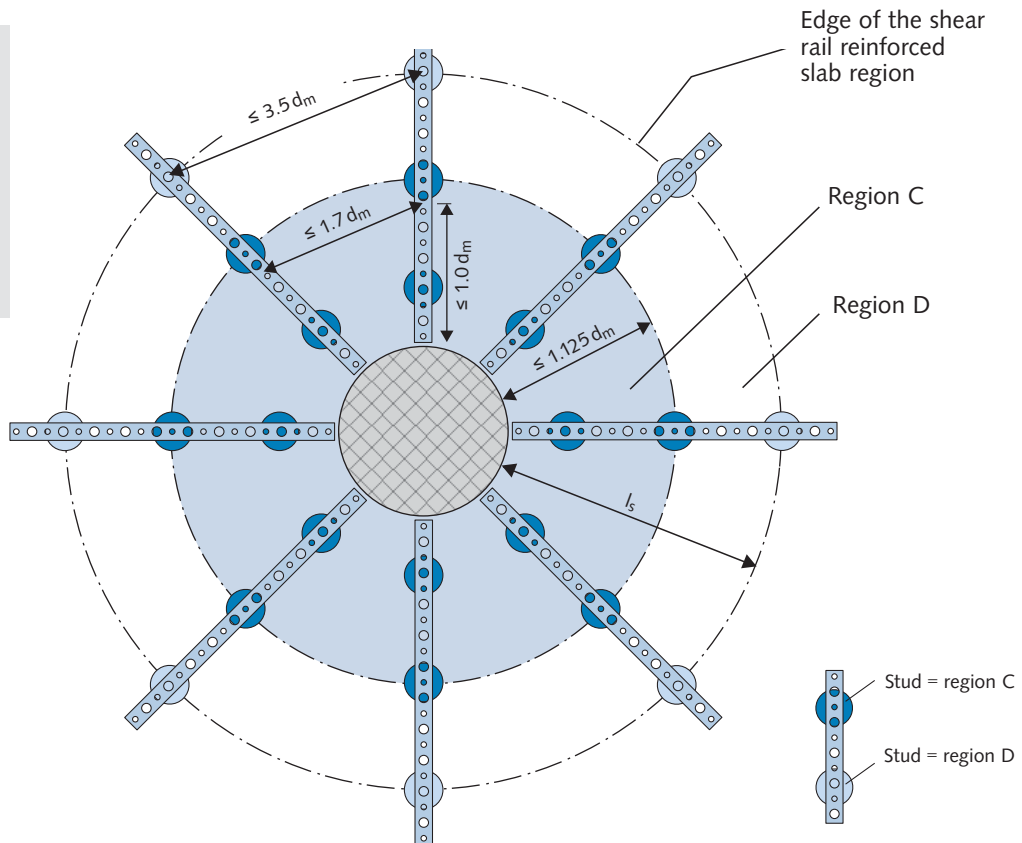

# HALFEN PUNCHING SHEAR REINFORCEMENT

## Installation Notes

### Arrangement of FDB II Punching shear reinforcement

In a precast concrete slab, the FDB II is installed parallel to the main lattice girders. FDB II Punching shear elements must be installed with the diagonal struts slanted towards the column i.e. in the direction of the axis. A main lattice girder can be installed between the first two FDB II elements closest to the column and the third FDB II element.

The upper reinforcement is placed directly on the upper chord of the FDB II punching shear reinforcement. Ensure the loops are aligned in one axis when installing the punching shear reinforcement in the prefabricated element. Only one FDB II may be installed with an offset.

The maximum diameter of the flexural reinforcement is 25 mm.

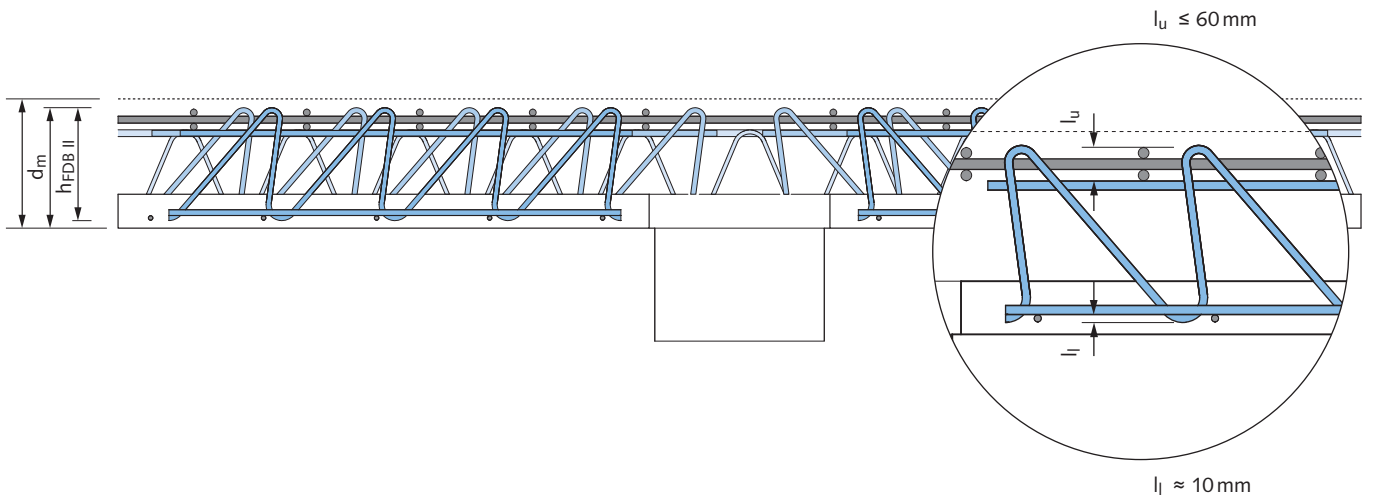
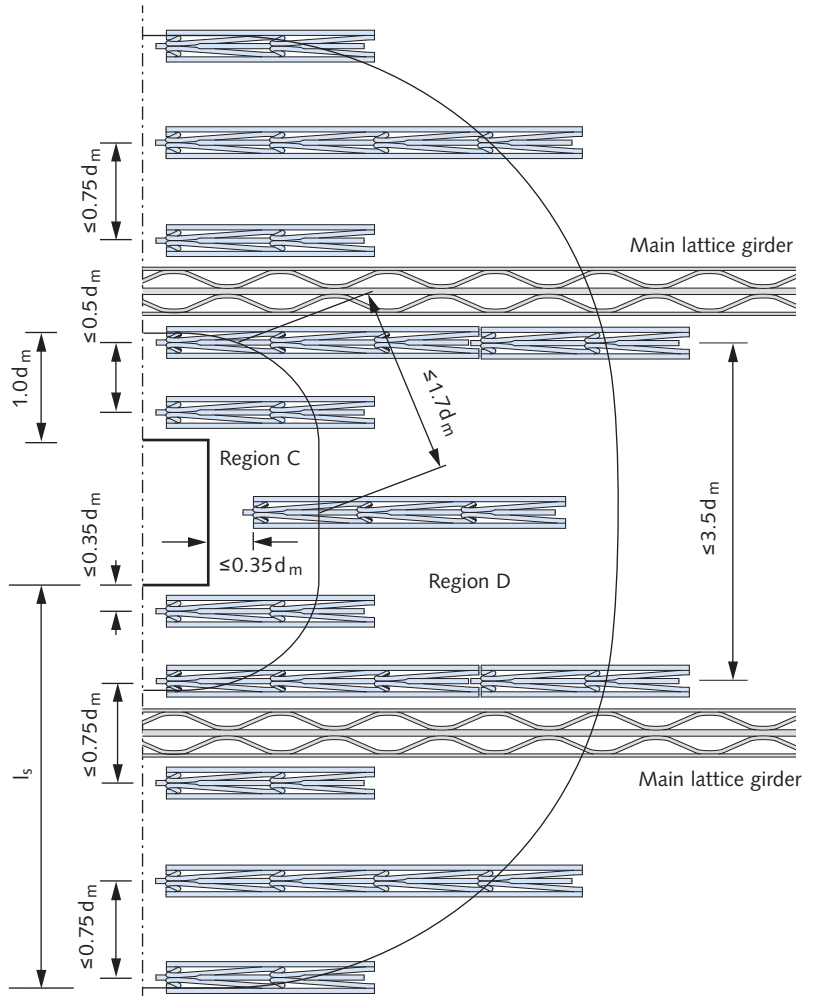



# HALFEN HDB SHEAR DOWELS – PUNCHING SHEAR REINFORCEMENT



## Installation Notes HDB – According to Column Geometry

### Layout of HDB elements

Depending on the proximity of the columns to the slab edges and the geometric shape of the columns, different HDB Shear rails layouts are necessary.



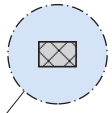
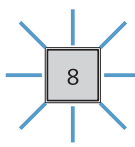
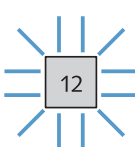
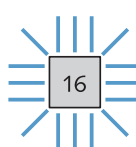
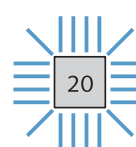
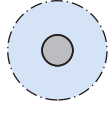
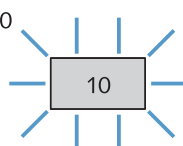
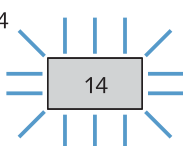
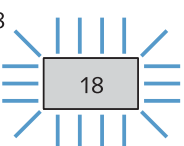
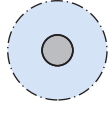
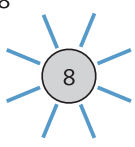
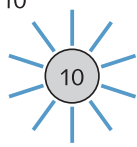
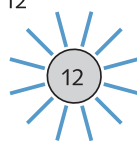
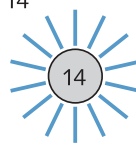
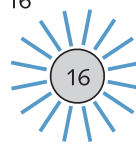
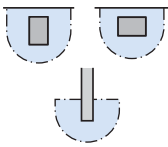
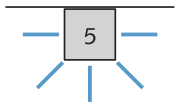
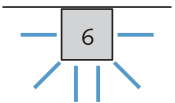
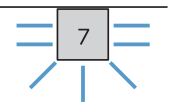
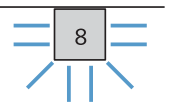
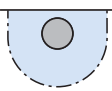
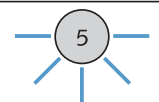
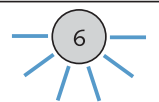
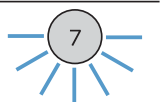
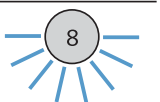
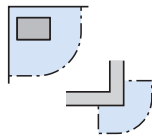
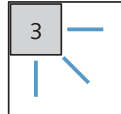
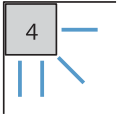
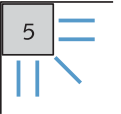

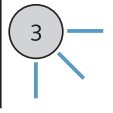
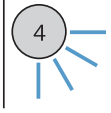
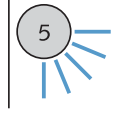



Even if only a few HDB elements are mathematically required for a low load, additional punching shear elements may be necessary to meet the mandatory maximum space requirements between the studs (see also page 15).

Table: Standard element combinations

 Edge of the shear reinforced slab region	A 8	A 12	A 16	A 20	
					
	B 10	B 14	B 18		
					
	C 8	C 10	C 12	C 14	C 16
					
	D 5	D 6	D 7	D 8	
					
	E 5	E 6	E 7	E 8	
					
	F 3	F 4	F 5		
					
	G 3	G 4	G 5		
					

# HALFEN HDB-S SHEAR RAIL – SHEAR REINFORCEMENT

## Calculation Table

Anchor cross-section for each element row $a_{sw,HDB-S}$ [cm <sup>2</sup> /m]										
stud distance $s_{L,HDB}$ [mm]	element length $L_E$ [mm]		stud diameter $d_A$ [mm]							studs/m
	2-stud	3-stud	10	12	14	16	18	20	25	
										
60	120	180	13.12							16.7
65	130	195	12.10							15.4
70	140	210	11.23							14.3
75	150	225	10.45	15.04						13.3
80	160	240	9.82	14.14						12.5
85	170	255	9.27	13.35	18.16					11.8
90	180	270	8.72	12.55	17.09					11.1
95	190	285	8.25	11.88	16.16					10.5
100	200	300	7.85	11.31	15.39	20.11				10.0
105	210	315	7.46	10.74	14.62	19.10				9.5
110	220	330	7.15	10.29	14.01	18.30	23.16			9.1
115	230	345	6.83	9.84	13.39	17.49	22.14			8.7
120	240	360	6.52	9.39	12.78	16.69	21.12	26.08		8.3
125	250	375	6.28	9.05	12.32	16.08	20.36	25.13		8.0
130	260	390	6.05	8.71	11.85	15.48	19.59	24.19		7.7
135	270	405	5.81	8.37	11.39	14.88	18.83	23.25		7.4
140	280	420	5.58	8.03	10.93	14.28	18.07	22.31		7.1
145	290	435	5.42	7.80	10.62	13.87	17.56	21.68		6.9
150	300	450	5.26	7.58	10.31	13.47	17.05	21.05	32.89	6.7
155	310	465	5.11	7.35	10.01	13.07	16.54	20.42	31.91	6.5
160	320	480	4.95	7.13	9.70	12.67	16.03	19.79	30.93	6.3
165	330	495	4.79	6.90	9.39	12.26	15.52	19.16	29.94	6.1
170	340	510	4.63	6.67	9.08	11.86	15.01	18.54	28.96	5.9
175	350	525	4.48	6.45	8.77	11.46	14.50	17.91	27.98	5.7
180	360	540	4.40	6.33	8.62	11.26	14.25	17.59	27.49	5.6
185	370	555	4.24	6.11	8.31	10.86	13.74	16.96	26.51	5.4
190	380	570	4.16	5.99	8.16	10.66	13.49	16.65	26.02	5.3
195	390	585	4.01	5.77	7.85	10.25	12.98	16.02	25.03	5.1
200	400	600	3.93	5.65	7.70	10.05	12.72	15.71	24.54	5.0
205	410	615	3.85	5.54	7.54	9.85	12.47	15.39	24.05	4.9
210	420	630	3.77	5.43	7.39	9.65	12.21	15.08	23.56	4.8
215	430	645	3.69	5.32	7.24	9.45	11.96	14.77	23.07	4.7
220	440	660	3.53	5.09	6.93	9.05	11.45	14.14	22.09	4.5
225	450	675	3.46	4.98	6.77	8.85	11.20	13.82	21.60	4.4
230	460	690	3.38	4.86	6.62	8.65	10.94	13.51	21.11	4.3
235	470	705	3.38	4.86	6.62	8.65	10.94	13.51	21.11	4.3
240	480	720	3.30	4.75	6.47	8.44	10.69	13.19	20.62	4.2
245	490	735	3.22	4.64	6.31	8.24	10.43	12.88	20.13	4.1
250	500	750	3.14	4.52	6.16	8.04	10.18	12.57	19.63	4.0

stud spacing  $s_{L,HDB-S} < 6 d_s!$

# HALFEN HDB / HDB-S SHEAR RAIL - PUNCHING SHEAR / SHEAR REINFORCEMENT

## Type Selection System Elements

HDB Element lengths L with stud diameter  $d_A$  [mm]

$\varnothing d_A$ (a)	$\varnothing 10$		$\varnothing 12$		$\varnothing 14$		$\varnothing 16$		$\varnothing 18$		$\varnothing 20$		$\varnothing 25$		stud spacing $L_A$ [mm]
	number of studs (c)	II	III	II	III	II	III	II	III	II	III	II	III		
stud height $h_A$ (b) [mm] ②															
105	#	#	-	-	-	-	-	-	-	-	-	-	-	-	80
115	#	#	-	-	-	-	-	-	-	-	-	-	-	-	80
125	#	#	#	#	#	#	-	-	-	-	-	-	-	-	100
135	200	300	#	#	#	#	-	-	-	-	-	-	-	-	100
145	200	300	#	#	#	#	-	-	-	-	-	-	-	-	100
155	220	330	220	330	#	#	#	#	-	-	-	-	-	-	110
165	240	360	240	360	#	#	#	#	-	-	-	-	-	-	120
175	240	360	240	360	#	#	#	#	-	-	-	-	-	-	120
185	280	420	280	420	280	420	#	#	-	-	#	#	-	-	140
195	280	420	280	420	280	420	#	#	-	-	#	#	-	-	140
205	280	420	280	420	280	420	280	420	#	#	#	#	-	-	140
215	300	450	300	450	300	450	300	450	300	450	#	#	-	-	150
225	#	#	320	#	320	480	320	#	320	#	#	#	-	-	160
235	#	#	340	510	340	510	340	510	340	510	340	510	#	#	170
245	#	#	360	540	360	540	360	540	360	540	360	540	#	#	180
255	#	#	#	#	360	540	360	540	360	540	360	540	#	#	180
265			#	#	#	#	#	#	#	#	#	#	#	#	200
275			#	#	#	#	400	600	400	600	400	#	#	#	200
285			#	#	420	630	420	630	420	630	420	630	#	#	210
295			#	#	#	#	440	#	440	660	440	660	#	#	220
305			#	#	#	#	#	#	-	-	440	660	#	#	220
315			#	#	#	#	#	#	-	-	#	#	#	#	240
325					#	#	#	#	-	-	#	#	#	#	240
335							#	#	-	-	480	#	#	#	240
345			#	#	#	#	#	#	-	-	#	#	#	#	260
355							#	#	-	-	520	#	#	#	260
365					#	#	#	#	-	-	#	#	#	#	270
375									-	-	#	#	#	#	280
395									-	-	#	#	#	#	300
405									-	-	#	#	#	#	300
425									-	-	#	#	#	#	320
435									-	-	#	#	#	#	320
455									-	-	#	#	#	#	320

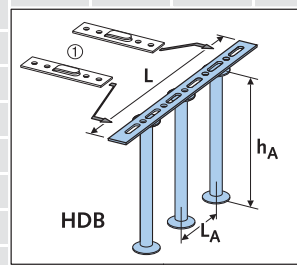

Note: Other element dimensions are ordered as HDB complete elements

- 420 System element standard design (dark grey)  
→ for example, element length  $L = 420$  mm (see order example)
- # System element available on request (light grey)  
→ element length on request
- Not available

- ① Assembly clip bars are ordered separately (see page 31).
- ② Other stud heights on request.

Order example   

**HDB - 16 / 205 - 3 / 420**

Type \_\_\_\_\_

Stud diameter  $d_A$  [mm] (a) \_\_\_\_\_

Stud height  $h_A$  [mm] (b) \_\_\_\_\_

Number of studs per element (c) \_\_\_\_\_

Element length  $L$  (set or required value) \_\_\_\_\_

# HALFEN HDB-S SHEAR RAIL – SHEAR REINFORCEMENT

## Simplified Calculation

Simplified calculation with a FE-calculation program and selection of the HDB-S Shear rails

Reinforced concrete slabs are currently mainly calculated with finite-elements based calculation programs. The following describes a simple method to determine the required shear stress reinforcement based on FE calculations. This avoids the complexity required with a separate calculation of HDB-S shear stress reinforcement.

**Example:**  
 Single axis spanned reinforced concrete slab  $L = 6\text{ m}$ ;  
 concrete C20/25;  $h = 20\text{ cm}$ ;  $d = 16\text{ cm}$ ;  $\rho_l = 0.5\%$ ;  
 transverse reinforcement 50%; live load  $q_k = 10\text{ kN/m}^2$ ;  
 the program automatically takes the dead-load into account.  
 A wall in the middle of the slab is assumed as a linear load:  
 $w_k = 50\text{ kN/m}$   
 Concrete cover  $c_{nom} = 2.5\text{ cm}$

### 1. Calculating a reinforced concrete slab using FE-software

- it is recommended to use a variable inclination of the compression strut method for shear design

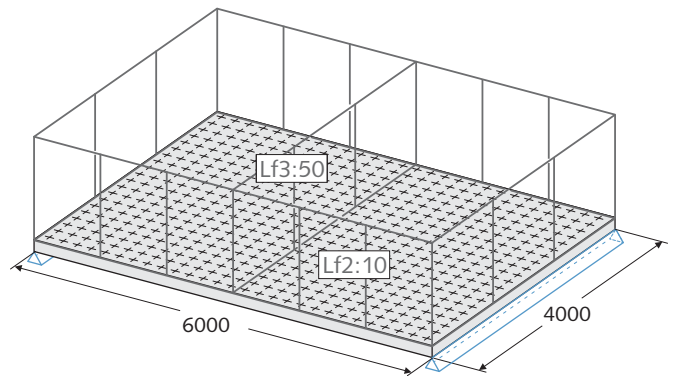

### 2. Calculating the required shear reinforcement using FE-calculation software

- checking the maximum load capacity ( $V_{Rd,max} > V_{Ed}$ )
- calculating the concrete load capacity ( $V_{Rd,c}$ )
- required shear reinforcement output

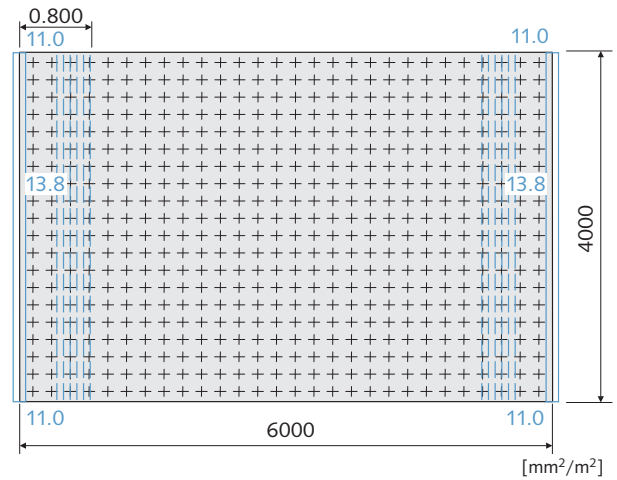

### 3. Distribution in plan

- dividing the plan into identical amounts of shear reinforcement
- calculating the dimension of each individual area

The result from this example was two areas with a length of 80cm and a width of 400cm

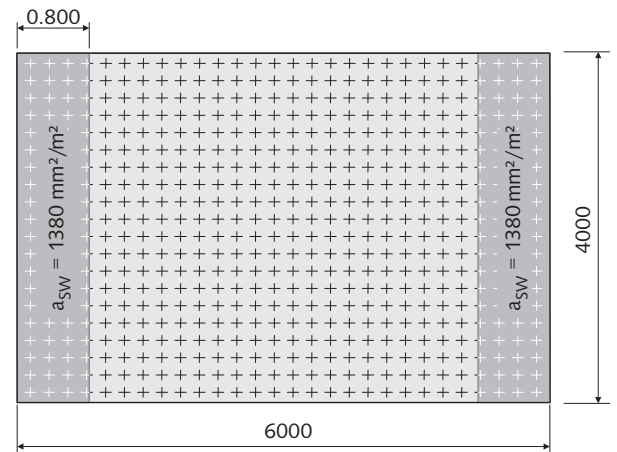



# HALFEN HDB-S SHEAR RAIL – SHEAR REINFORCEMENT

## Simplified Calculation

### Simplified calculation with a FE-calculation program and selection of the HDB-S Shear rails

#### 4. Calculating the allowable crosswise and lengthwise spacing for HDB-S Anchor (see page 26)

- checking the boundary conditions
- allowable anchor spacing in slab span direction ( $s_{L,HDB-S}$ )
- allowable anchor spacing transverse to slab span direction ( $s_{Q,HDB-S}$ )

#### 5. Calculating the anchor height and defining a grid for the HDB-S Anchor (further notes on page 26)

- distribution of anchors according to the approved anchor spacing
- if possible consider spacings with HDB Anchors available from standard stock (see page 23)

#### 6. Defining the required anchor diameter (see table on page 22)

- calculating the required anchor diameters using the selected anchor spacings and the required reinforcement cross-section

#### 7. Establishing the number of elements and compiling an item list

- calculating the required number of element rows
- dividing the anchor row into 2 and 3 anchor-elements
- checking present edge spacing against the minimal required edge spacing (see page 26)
- understanding the element description (see page 30)

Data from the FE-Program:

- maximum load capacity  $V_{Rd,max} = 440 \text{ kN/m}$
- concrete load capacity  $V_{Rd,c} = 69.5 \text{ kN/m}$
- load  $V_{Ed} = 96.0 \text{ kN/m}$
- utilisation factor  $V_{Ed}/V_{Rd,max} = 0.22$

required boundary conditions

- slab thickness  $h = 20 \text{ cm} \geq 16 \text{ cm} (h_{min})$

Maximal anchor spacing (see page 26):

- max. lengthwise spacing  $s_{L,HDB-S} = 0.8 h = 16 \text{ cm}$
- max. crosswise spacing  $s_{Q,HDB-S} = 1.5 h = 30 \text{ cm}$

Calculating anchor height:

- anchor height  $h_A = h - 2 \times c_{nom} = 200 - 2 \times 25 = 150 \text{ mm}$   
selected:  $h_A = 155 \text{ mm}$

selected anchor spacing:

- lengthwise  $s_{L,HDB-S} = 16 \text{ cm} \approx 5 \text{ anchors/elements row}$
- crosswise  $s_{Q,HDB-S} = 30 \text{ cm} \approx 3.3 \text{ elements/m}$

given:

- required shear reinforcement  $a_{sw,req} = 13.8 \text{ cm}^2/\text{m}^2$
  - cross-section per element row  $a_{sw,req} = 13.8/3.3 = 4.2 \text{ cm}^2/\text{m}$
- selected anchor diameter (see table on page 22)
- anchor diameter  $d_A = 10 \text{ mm}$
- present shear reinforcement:  $a_{sw,actual} = 4.95 \times 3.3 = 16.3 \text{ cm}^2/\text{m}^2$
- Verification
- $a_{sw,actual} > a_{sw,req}$

Distribution of elements:

- number of anchor rows  $m = 400/30 = 13 \text{ rows}$
- no. of anchor in each row  $n = 80/16 = 5 \text{ anchors}$
- configuration: 13 elements rows, each with one 2-stud and one 3-stud HDB-S element

checking the present edge spacing (see page 19)

- present edge spacing  $\rightarrow a_{Q,HDB-S} = (400 - 12 \times 30)/2$   
 $\rightarrow \text{present } a_{Q,HDB-S} = 20.0 \text{ cm}$   
 $> \min a_{Q,HDB-S} = 12.0 \text{ cm}$

Element description:

- HDB-S -  $d_A / h_A - n / L_{Ges}$  ( $L_{Ges} = n \times s_{L,HDB-S}$ )

Parts list and element description:

- $2 \times 13 \times \text{HDB-S-10/155-2/320} (80 / 160 / 80)$
- $2 \times 13 \times \text{HDB-S-10/155-3/480} (80 / 160 / 160 / 80)$

# HALFEN HDB-S SHEAR RAIL – SHEAR REINFORCEMENT

## Installation Notes

### Allowable anchor spacings

The maximal anchor spacing, longitudinal and transverse, depends on the thickness of the slab and the loads in the following table. When absolute and relative values are provided the lower of the two is decisive.

The first anchor in a row is placed at a distance of  $s_{L,HDB-S}$  from the centre line of the load. In addition, the transverse spacing also depends on the transverse reinforcement.

With transverse reinforcement values between 20% and 50%, the allowable transverse spaces may also be linearly interpolated. In single-axis-span slabs a transverse reinforcement of at least 20% of the main reinforcement is required for tension forces and transverse bending moments.

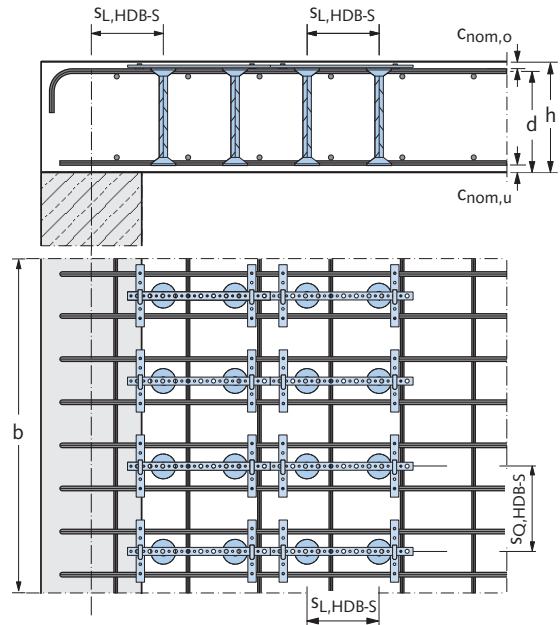

shear load force	slab thickness h [cm]	maximum anchor spacing in support direction $s_{L,HDB-S}^*$	maximum anchor distance in transverse direction $s_{Q,HDB-S}^*$ transverse reinforcement	
			20%	50%
$V_{Ed} \leq 0.3 V_{Rd,max}$	$h \leq 40$	0.8 h	1.0 h	1.5 h
	$h > 40$	0.7 h or 30 cm	1.0 h or 80 cm	1.0 h or 80 cm
$0.3 V_{Rd,max} < V_{Ed} < 0.6 V_{Rd,max}$	$h \leq 40$	0.6 h	1.0 h	1.5 h
	$h > 40$	0.5 h or 30 cm	1.0 h or 60 cm	1.0 h or 60 cm
$V_{Ed} \geq 0.6 V_{Rd,max}$	$h \leq 40$	0.25 h	1.0 h	1.5 h
	$h > 40$	0.25 h or 20 cm	1.0 h or 60 cm	1.0 h or 60 cm

\* The anchor distance applies for concrete grades  $\leq C45/55$ .  
See general building approval Z-15.1-249 and Z-15.1-270 for anchor spacing for concrete grades C50/60.

### Installation notes

Reinforcement stirrups must be placed in all free edges of slabs to secure and hold the concrete cover. At least one longitudinal reinforcement bar must be placed at anchor head height

between the free component edges and the HDB-S anchor. The minimal edge spacing  $a_{Q,HDB-S}$  and minimal slab thickness for each anchor diameter can be found in the following table.

anchor diameter $d_A$ [mm]	minimal slab thickness h [cm]	minimal anchor space to free edges depending on the concrete strength class $a_{Q,HDB-S}$ [cm]				
		C 20/25	C 30/37	C 35/45	C 45/55	C 50/60
10	16*	12	11	9	8	8
12	16*	15	13	11	10	10
14	16*	17	15	13	12	12
16	16	20	17	15	13	13
18	20.5	23	19	17	15	15
20	25	25	21	19	17	17
25	39.5	31	26	23	21	21

\* minimal slab thickness according to the German National Annex NA(D) for EN 1992-1-1:2011-01

# HALFEN HDB / HDB-S SHEAR RAIL – PUNCHING SHEAR / SHEAR REINFORCEMENT

## Calculation Software

*The HALFEN Calculation program is a convenient tool to help calculate the punching shear and shear reinforcement.*

The program was compiled based on current approvals and expert reports. The program helps to determine the optimal punching and shear reinforcement for the required slab geometry and loads. A selection of calculation methods based on national and international standards and approvals are integrated in the software.



The current version of the calculation software now includes easy calculation of FILIGRAN FDB II Punching shear reinforcement in filigree slabs.

① Hegger, J.; Roeser, W.: Calculation of HDB-S-Anchors according to Eurocode 2 based on the National Annex for Germany. Expert report H+P Ingenieure, Aachen 2011.

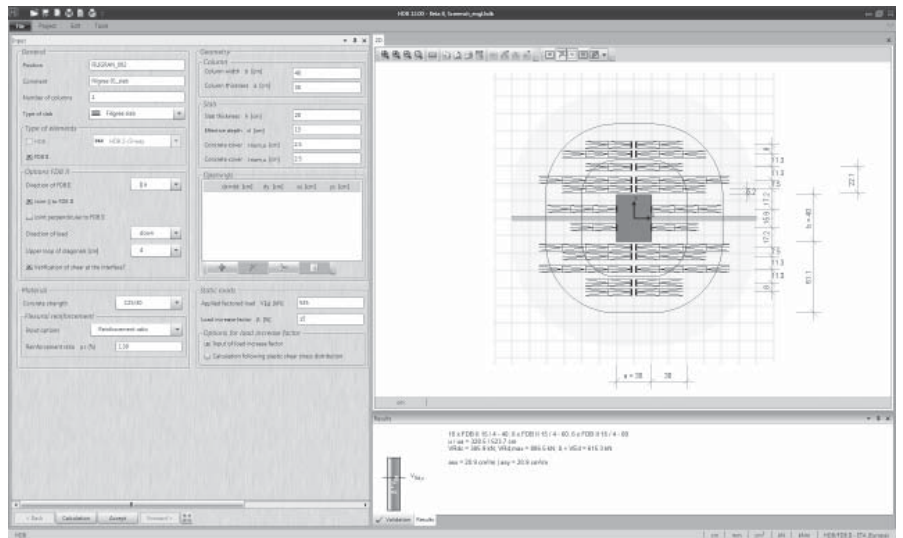

FDB II Punching shear reinforcement can be selected as an alternative to HDB Shear rails for cast on-site concrete slabs. Calculation of the FDB II complies with all the guidelines in the ETA-13/0521 approval, ensuring the high maximum load capacity of the FDB II elements is fully and safely utilized. Essentially the same programme features as for HDB Shear rails are available. The calculation software also includes a calculation of shear loads based on an expert report published by Prof. Dr. Hegger/ Dr. Roeser, H+P Ingenieure, Aachen<sup>①</sup>.

The calculation method in the report is based on EN 1992-1-1:2011-01 and the relevant National German Annex NA(D). This ensures unproblematic application in Germany compliant with the current generation of European standards. The expert report forms the basis for EN 1992-1-1 and the modified Building Authority Approval for HDB-S (Z-15.1-249 and Z-15.1-270) for the relevant National German Annex NA(D). Therefore, the program is suitable for HDB Shear rails in punching shear reinforcement applications and also in shear stress reinforcement applications.

### Project administration

Any number of different positions can be calculated within a project and stored in the project data-file; this data is immediately accessible to the user for further editing. The data should be confirmed after every calculation by selecting the 'Accept' button; otherwise previous data will be overwritten by subsequent input. An administration window enables quick navigation through the project data.

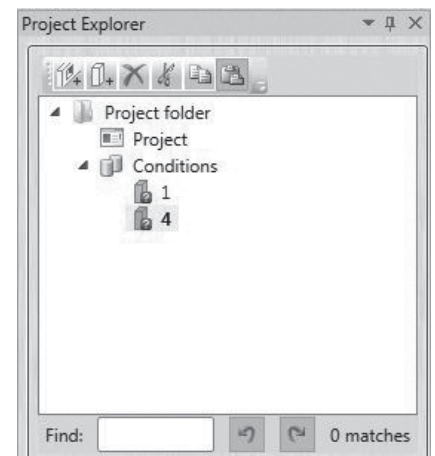

# HALFEN PUNCHING SHEAR / SHEAR REINFORCEMENT

## Calculation Software

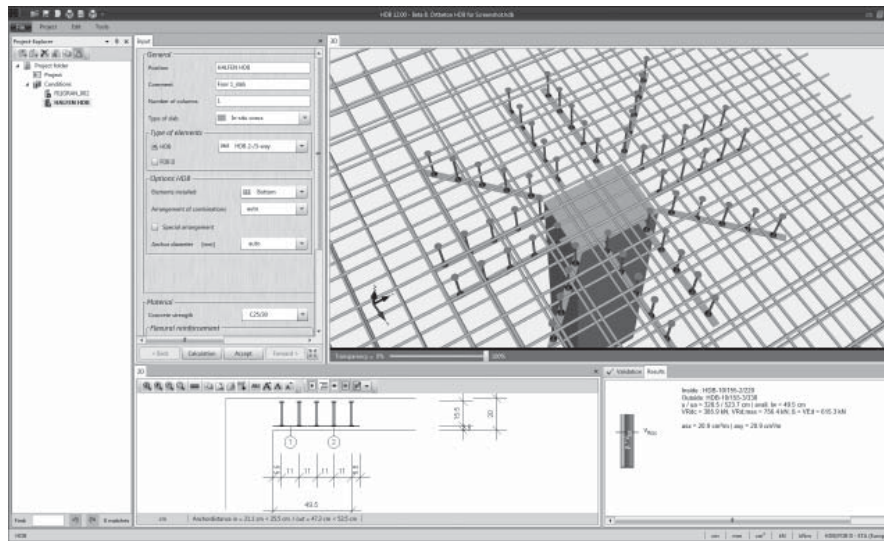

### Design alternatives

Punching shear calculation is possible for floor slabs (semi-precast and on-site cast concrete slabs) foundations and footings. Depending on the application HDB Shear rails or FDB II Punching shear reinforcement may be selected for on-site cast concrete slabs. FDB II Punching shear reinforcement is preferred for use in filigree slabs. Punching shear resistance in foundation slabs or footings can be effectively increased using HDB Shear rails. System-elements with 2 or 3 anchors or complete elements can be selected for HDB Punching shear rails. All elements can be installed from above or from below. Anchor diameters (10, 12, 14, 16, 18, 20 or 25 mm) can be selected automatically and optimally by the software program or user specified diameters can be entered manually. This also applies when selecting combinations of punching shear elements. In standard mode the program automatically optimizes the number of HDB Elements. It is possible to freely select the number of elements manually to individual requirements in compliance with the approval.

The installation direction of the elements and a loop projection between 3 cm to 6 cm can be selected for the FDB II Punching shear reinforcement. The program automatically optimises the layout of the FDB II Punching shear reinforcement.

According to the approval, two methods are available to determine the load increase factor:

- constant load factor according to EN 1992-1-1,
- a more precise method using a plastic shear stress distribution according to EN 1992-1-1:2011-01.

### Openings

Openings close to the punching shear region can be considered simply by defining their dimensions and the area's centroid.

Openings				
	$dx=dd$ [cm]	$dy$ [cm]	$x_s$ [cm]	$y_s$ [cm]
1	20	20	40	60

### Shear stress calculation

The program verifies the shear loads for end or intermediate supports in concrete slabs. Using the geometry, loads and the shear force at the supports, provided by the user, the program calculates the respective shear stresses. The shear force is subsequently verified in accordance with the expert report by Hegger/Roeser and if required, shear reinforcement (HDB-S- Shear rails) are selected. Alternatively the design shear force or the required shear reinforcement can be entered directly into the program. If the slab has already been calculated with a FE-Program and the required shear stress reinforcement per square-meter is known, then this information can be entered and directly converted into HDB-S-Shear stress reinforcement using the HDB-Program. If the design shear force is known, then the HDB-Program can select the required HDB-S- shear stress reinforcement in accordance with the Hegger/Roeser expert report. The HDB-software calculates "infinite" expanded floor-slabs as well as discrete slab strips. In addition, it is also possible to enter any number of contributory floor-slabs. These can either be estimated or be selected more realistically using secondary sources, for example. Journal no. 240 published by the German Committee for Structural Concrete (*DAfStb, Deutscher Ausschuss für Stahlbeton*). The shear stress resistance near interior and exterior walls in foundation-slabs can also be verified. The same calculation options are basically available as for floor-slabs.



# HALFEN PUNCHING SHEAR / SHEAR REINFORCEMENT

## Calculation Software

### Edit window

The edit window is used to display the system geometry; available in 2D or 3D. The 2D modus is used to edit or delete shear rails. Any openings can also be moved.

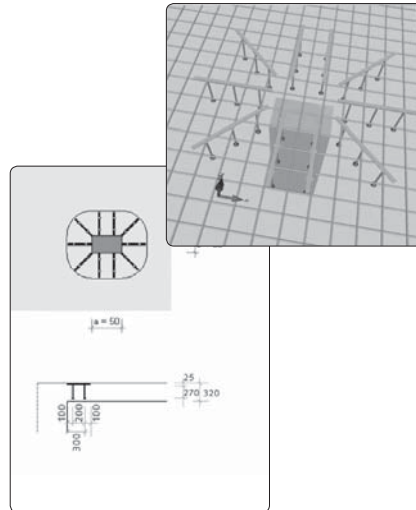

### Internet download

The current version of the calculation program is available on the internet at [www.halfen.com](http://www.halfen.com) for free download.

If the option is selected, the HDB-Software will automatically check – every time the program is started – if a newer version of the program is available.

A DVD with all calculation programs, catalogues and approvals is also available on request. Contact addresses can be found at the back of this catalogue.

### Drawing print-out; DXF

DXF data can be created with a plan view, section and optional dimensioning information. This data can then be integrated into reinforcement plans.

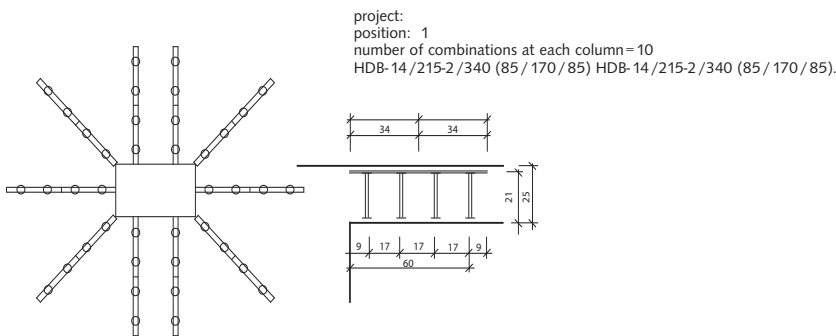

### System requirements for the HALFEN HDB design software:

- Windows 8.x, Windows 7
- Microsoft .NET Framework 4.5

### Printouts

After calculating the punching shear or shear stress reinforcement the HDB Calculation program creates a calculation report, the required plans, parts lists and if requested, an order list.

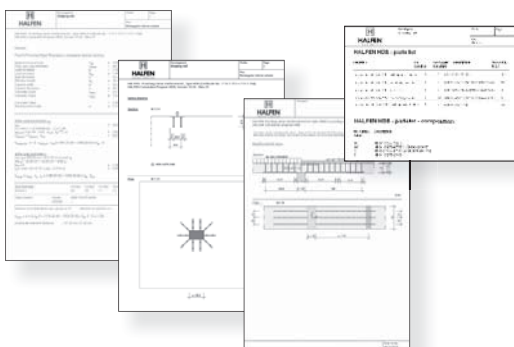

# HALFEN PUNCHING SHEAR / SHEAR REINFORCEMENT

## Type Selection, Order Information, Accessories

### Order description HDB/FDB II

**Dimensioning**  
of HDB Shear rails  
as punching shear  
and shear force  
reinforcement

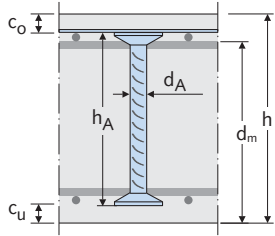

**HDB System elements**  
2 or 3 studs

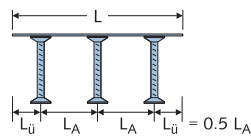

**HDB - 16 / 205 - 3 / 420**  
type stud dimensions  $d_A / h_A$  number of studs element length L

**HDB Complete elements**  
2 - 10 studs

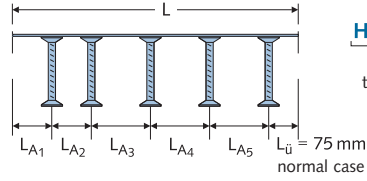

**HDB - 16 / 205 - 5 / 725** (100 / 100 / 150 / 150 / 150 / 75)  
type stud dimensions  $d_A / h_A$  number of studs element length L stud spacings  $L_{A1}/L_{A2}/\dots/L_{An}$  end spacing  $L_u$

**FDB II Elements**

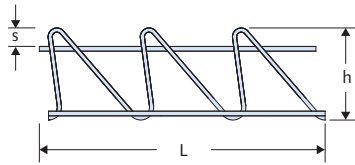

**FDB II 20 / 5 - 60**  
type element-height h loop projection - top s element length L

**Installation accessories**

**Clip bars**

Optional; not always required.  
To facilitate top installation, we generally recommend calculating an average of 1.5 clip bars for HDB elements (see page 31).

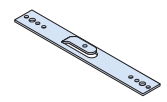

**HDB KLEMM**  
type

**Spacer**

For installation from below i.e. with HDB Complete elements.  
The dimension  $c_u$  depends on the concrete cover.  
Type selection (see page 31).



**HDB ABST - 30**  
type dimension  $c_u$

# HALFEN PUNCHING SHEAR / SHEAR REINFORCEMENT

## Accessories

### Installation of HDB/HDB-S to reinforcement

Installed at right angles to the top reinforcement (without clip bars)  
Shear rails (spacer bar) are installed perpendicular to the top reinforcement

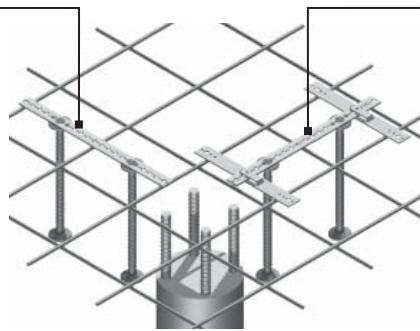
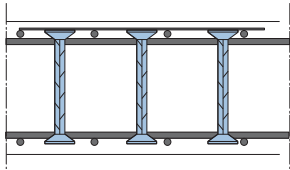

Installed parallel to the top reinforcement (with clip bars)

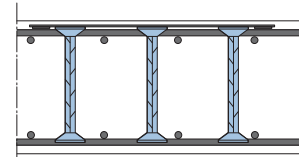

We generally recommend calculating an average of 1.5 clip bars for each HDB element

Clip bar  
HDB Klemm

Application scheme:

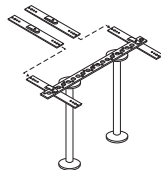
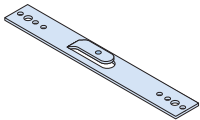

item name	dimensions [mm]	order no.
HDB Klemm	-35/3x275	00001

#### Note:

To avoid clip bars overlapping, they can be attached anywhere on the spacer bar. Clip bars are not included in scope of delivery.

**Please order these separately.**

### Spacer HDB ABST for installation from below

Spacer type HDB ABST - ①

Concrete cover  $c_{nom,o}$  and  $c_{nom,u}$  according to EN 1992-1-1:2011-01 and respective national annex

① State  $c_{nom,u}$  when ordering

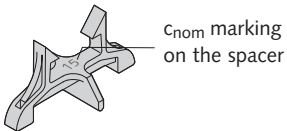

$c_{nom}$  marking on the spacer

item name: ① type dimension $c_{nom}$ [mm]	order no.
HDB ABST-15/20	00001
HDB ABST - 25	00002
HDB ABST - 30	00003
HDB ABST - 35	00004
HDB ABST - 40	00005

Material KS = plastic

Recommendation: Order 2 spacers per HDB element when installing from below.

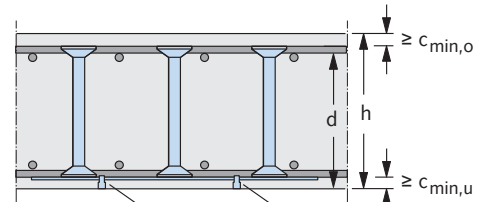

HDB ABST

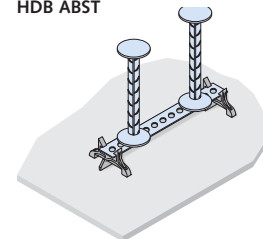

### Storage and transport

Note: When storing and transporting semi-precast slabs the punching shear reinforcement elements protrude above the lattice girders. Use appropriate height spacers to support the semi-precast slabs.

⚠ Higher spacers necessary!

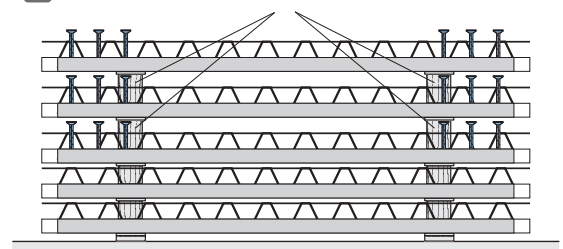

# HALFEN PUNCHING SHEAR / SHEAR REINFORCEMENT

## Tender Specification

### HDB Punching shear reinforcement

#### HALFEN HDB Shear rail (System element) - $d_A / h_A - n / L$

HALFEN Shear rail HDB as punching shear reinforcement in point-load-supported flat slabs or foundation slabs according to European Technical Approval ETA-12/0454; RAL-GZ 658/2; approved by the RAL quality control association for anchor and reinforcement technology (RAL *Gütegemeinschaft Verankerungs- und Bewehrungstechnik e.V.*), in ribbed or smooth reinforcement steel B 500, to strengthen punch-critical areas in flat slabs or foundation slabs for non-predominantly static and predominantly static loads.

#### Type HDB (System element) - $d_A / h_A - n / L$ with

stud diameter	$d_A = \dots\dots\dots$ [mm]
stud height	$h_A = \dots\dots\dots$ [mm]
number of studs	$n = \dots\dots\dots$ [studs / element]
length of shear rail	$L = \dots\dots\dots$ [mm]

or similar, deliver and install using clamps and spacers (accessories) according to the manufacturer's instructions.

**Note:** refer to the table on page 23 for sizes of available system elements.

### FDB II Punching shear reinforcement

#### FILIGRAN FDB II Punching shear reinforcement $h / s - L$ :

FILIGRAN FDB II Punching shear reinforcement in point-load-supported flat slabs or in slab areas with high single loads, according to European Technical Approval ETA-13/0521, made of ribbed reinforcing steel B500A, to strengthen punch-critical areas in flat slabs for non-predominantly static and predominantly static loads.

#### Type FDB II $h / s - L$

element height	$h = \dots\dots\dots$ [cm],
top loop projection	$s = \dots\dots\dots$ [cm],
element length	$L = \dots\dots\dots$ [cm]

or similar, deliver and install according to the manufacturer's instructions.

**Note:** for available dimensions refer to page 10

### HDB-S Shear reinforcement

#### HALFEN HDB-S Shear rail - $d_A / h_A - n / L$ (Stud spacing):

HALFEN Shear rail HDB-S as shear reinforcement in reinforced concrete slabs or beams according to Technical Approval Z-15.1-249 and Z-15.1-270; RAL-GZ 658/2; approved by the RAL quality control association for anchorage and reinforcement technology (RAL *Gütegemeinschaft Verankerungs- und Bewehrungstechnik e.V.*), in ribbed or smooth reinforcement steel B 500, to strengthen the critical shear areas in beams or slabs for non-predominantly static and predominantly static loads.

#### Type HDB-S - $d_A / h_A - n / L$ ( $L_{A1} / L_{A2} / \dots / L_{An} / L_{\ddot{u}}$ ) with

stud diameter	$d_A = \dots\dots\dots$ [mm]
stud height	$h_A = \dots\dots\dots$ [mm]
number of studs	$n = \dots\dots\dots$ [Studs / Element]
length of shear rail	$L = \dots\dots\dots$ [mm]
stud distances	$L (L_{A1} / L_{A2} / \dots / L_{An} / L_{\ddot{u}})$ $= \dots\dots\dots$ [mm]

or similar, deliver and install using clip bars and spacers (accessories) according to the manufacturer's instructions.

Further tender specifications can be found at [www.halfen.com](http://www.halfen.com) under 'Service'



# HALFEN PUNCHING SHEAR / SHEAR REINFORCEMENT

## References



Kö-Bogen, Düsseldorf (Germany)



Galeria Drukarnia, Bydgoszcz (Poland)



Underground car park, Wattwil (Switzerland)



Sky Tower, Wrocław (Poland)



Rondo Business Park, Krakow (Poland)

# Let us take the load

## HALFEN Punching shear reinforcement and shear reinforcement

**The HALFEN Punching shear and shear reinforcement enables you to produce flat reinforced concrete slabs economically and safely. The benefits are low formwork costs, optimized use of space and easy installation of additional fittings.**

### Established product

HALFEN HDB Shear rail with forged double-headed studs.

### Maximum safety

HALFEN HDB Shear rails provide up to 40% higher punching shear load capacity than conventional stirrup reinforcement.

### Flexible system

Standardised system elements for 2 or 3 studs that can be combined as required, or manufacture of project-related complete elements.

### Quick assembly

Quick and correct installation of the HALFEN HDB Shear rails is ensured when using HDB Accessories.

### Perfect solution

The new FILIGRAN FDB II Punching shear reinforcement ensures highest load capacity together with easy and fast installation in semi-precast slabs and on-site cast concrete slabs.



HALFEN HDB Dübelleiste

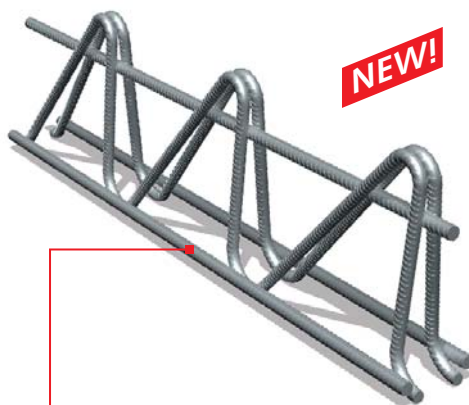

Innovation price for FILIGRAN FDB II:



### Customer service

The user-friendly HALFEN Software provides support for dimensioning the punching shear reinforcement in flat slabs, filigree slabs, foundation slabs and single foundations footings. The program also enables efficient calculation of HALFEN HDB-S Shear rails as shear reinforcement in accordance with Eurocode 2. The software automatically generates lists of parts and DXF files for direct import into CAD programs. The software is available for free download at [www.halfen.com](http://www.halfen.com).

### Safety and quality

With 20 years experience in the production of HALFEN HDB Shear rails and as an ISO 9001 certified manufacturer we provide first-class products, quality checked by regular in-house and external production control.

**Many reasons, one conclusion: HALFEN products mean safety, quality and protection – for you and your company.**



## CONTACT HALFEN WORLDWIDE

HALFEN is represented by subsidiaries in the following 14 countries, please contact us:

Austria	HALFEN Gesellschaft m.b.H. Leonard-Bernstein-Str. 10 1220 Wien	Phone: +43-1-259 6770 E-Mail: office@halfen.at Internet: www.halfen.at	Fax: +43-1-259-677099
Belgium/ Luxembourg	HALFEN N.V. Borkelstraat 131 2900 Schoten	Phone: +32-3-658 07 20 E-Mail: info@halfen.be Internet: www.halfen.be	Fax: +32-3-658 15 33
China	HALFEN Construction Accessories Distribution Co.Ltd. Room 601 Tower D, Vantone Centre No. A6 Chao Yang Men Wai Street Chaoyang District Beijing · P.R. China 100020	Phone: +86-10 5907 3200 E-Mail: info@halfen.cn Internet: www.halfen.cn	Fax: +86-10 5907 3218
Czech Republic	HALFEN s.r.o. Business Center Šafránková Šafránková 1238/1 155 00 Praha 5	Phone: +420-311-690 060 E-Mail: info@halfen-deha.cz Internet: www.halfen-deha.cz	Fax: +420-235-314 308
France	HALFEN S.A.S. 18, rue Goubet 75019 Paris	Phone: +33-1- 445231 00 E-Mail: halfen@halfen.fr Internet: www.halfen.fr	Fax: +33-1-44523152
Germany	HALFEN Vertriebsgesellschaft mbH Liebigstr. 14 40764 Langenfeld	Phone: +49-2173-970-0 E-Mail: info@halfen.de Internet: www.halfen.de	Fax: +49-2173-970 225
Italy	HALFEN S.r.l. Soc. Unipersonale Via F.lli Bronzetti N° 28 24124 Bergamo	Phone: +39-035-0760711 E-Mail: info@halfen.it Internet: www.halfen.it	Fax: +39-035-0760799
Netherlands	HALFEN b.v. Oostermaat 3 7623 CS Borne	Phone: +31-74-267 14 49 E-Mail: info@halfen.nl Internet: www.halfen.nl	Fax: +31-74-267 26 59
Norway	HALFEN AS Postboks 2080 4095 Stavanger	Phone: +47-51 82 34 00 E-Mail: post@halfen.no Internet: www.halfen.no	Fax: +47-51 82 34 01
Poland	HALFEN Sp. z o.o. Ul. Obornicka 287 60-691 Poznan	Phone: +48-61-622 14 14 E-Mail: info@halfen.pl Internet: www.halfen.pl	Fax: +48-61-622 14 15
Sweden	Halfen AB Vädursgatan 5 412 50 Göteborg	Phone: +46-31-98 58 00 E-Mail: info@halfen.se Internet: www.halfen.se	Fax: +46-31-98 58 01
Switzerland	HALFEN Swiss AG Hertistrasse 25 8304 Wallisellen	Phone: +41-44-849 78 78 E-Mail: mail@halfen.ch Internet: www.halfen.ch	Fax: +41-44-849 78 79
United Kingdom/ Ireland	HALFEN Ltd. A1/A2 Portland Close Houghton Regis LU5 5AW	Phone: +44-1582-47 03 00 E-Mail: info@halfen.co.uk Internet: www.halfen.co.uk	Fax: +44-1582-47 03 04
United States of America	HALFEN USA Inc. 8521 FM 1976 P.O. Box 547 Converse, TX 78109	Phone: +1 800.423.91 40 E-Mail: info@halfenusa.com Internet: www.halfenusa.com	Fax: +1 877.683.4910
<b>For countries not listed</b> HALFEN International	HALFEN International GmbH Liebigstr. 14 40764 Langenfeld /Germany	Phone: +49-2173-970-0 E-Mail: info@halfen.com Internet: www.halfen.com	Fax: +49-2173-970-849

Furthermore HALFEN is represented with sales offices and distributors worldwide. Please contact us: [www.halfen.com](http://www.halfen.com)

### NOTES REGARDING THIS CATALOGUE

**Technical and design changes reserved.** The information in this publication is based on state-of-the-art technology at the time of publication. We reserve the right to make technical and design changes at any time. HALFEN GmbH shall not accept liability for the accuracy of the information in this publication or for any printing errors.

The Quality Management System of Halfen GmbH is certified for the locations in Germany, France, the Netherlands, Austria, Poland, Switzerland and the Czech Republic according to **DIN EN ISO 9001:2008**, Certificate No. QS-281 HH.





For further information please contact: [www.halfen.com](http://www.halfen.com)