

Light design, high dynamics, cost-effective



e-chains® | E4.38L | Crossbars every link (openable along inner and outer radius, from both sides)
e-tubes | R4.38L | Fully enclosed (lids openable along inner and outer radius, from both sides)

Part No.	Part No.	Bi	Ba	E4.38L	R4.38L	Part No.	Part No.	Bi	Ba	E4.38L	R4.38L
e-chains®	e-tubes	[mm]	[mm]	[kg/m]	[kg/m]	e-chains®	e-tubes	[mm]	[mm]	[kg/m]	[kg/m]
E4.38L.050.R.0	R4.38L.050.R.0	050	066	≈ 1.13	≈ 1.20	E4.38L.225.R.0	-	225	241	≈ 1.97	-
E4.38L.062.R.0	-	062	078	≈ 1.19	-	E4.38L.237.R.0	-	237	253	≈ 2.05	-
E4.38L.075.R.0	R4.38L.075.R.0	075	091	≈ 1.26	≈ 1.38	E4.38L.250.R.0	R4.38L.250.R.0	250	266	≈ 2.11	≈ 2.65
E4.38L.087.R.0	-	087	103	≈ 1.30	-	E4.38L.262.R.0	-	262	278	≈ 2.15	-
E4.38L.100.R.0	R4.38L.100.R.0	100	116	≈ 1.37	≈ 1.60	E4.38L.275.R.0**	-	275	291	≈ 2.22	-
E4.38L.105.R.0	-	105	125	≈ 1.39	-	E4.38L.287.R.0**	-	287	303	≈ 2.30	-
E4.38L.112.R.0	-	112	128	≈ 1.44	-	E4.38L.300.R.0	R4.38L.300.R.0**	300	316	≈ 2.36	≈ 3.00
E4.38L.125.R.0	R4.38L.125.R.0	125	141	≈ 1.50	≈ 1.75	E4.38L.312.R.0**	-	312	328	≈ 2.40	-
E4.38L.137.R.0	-	137	153	≈ 1.55	-	E4.38L.325.R.0**	-	325	341	≈ 2.47	-
E4.38L.150.R.0	R4.38L.150.R.0	150	166	≈ 1.65	≈ 1.92	E4.38L.337.R.0**	-	337	353	≈ 2.55	-
E4.38L.162.R.0	-	162	178	≈ 1.69	-	E4.38L.350.R.0**	-	350	366	≈ 2.57	-
E4.38L.175.R.0	R4.38L.175.R.0	175	191	≈ 1.74	≈ 2.10	E4.38L.362.R.0**	-	362	378	≈ 2.60	-
E4.38L.187.R.0**	-	187	203	≈ 1.80	-	E4.38L.375.R.0**	-	375	391	≈ 2.65	-
E4.38L.200.R.0	R4.38L.200.R.0	200	216	≈ 1.86	≈ 2.29	E4.38L.387.R.0**	-	387	403	≈ 2.76	-
E4.38L.212.R.0**	-	212	228	≈ 1.90	-	E4.38L.400.R.0**	-	400	416	≈ 2.83	-

**Width available upon request. Please consult igus® for delivery time.

*Radius available upon request. Please consult igus® for delivery time. 1) Radius not available for e-tubes

Available bend radii

R [mm] | 063¹⁾ | 075¹⁾ | 100¹⁾ | 125 | 150 | 175 | 200 | 250 | 300 | 350*

Complete Part No. with required radius (R). Example:

E4.38L.100.150.0 = crossbars every link / R4.38L.100.150.0 = fully enclosed

Swarf up to +850°C

- e-tubes to withstand +850°C swarf, as a special option
- No hot swarf melting or embedding into the chain
- igus® igumid HT material

More information ► www.igus.co.uk/HT



Unsupported applications | Short travel

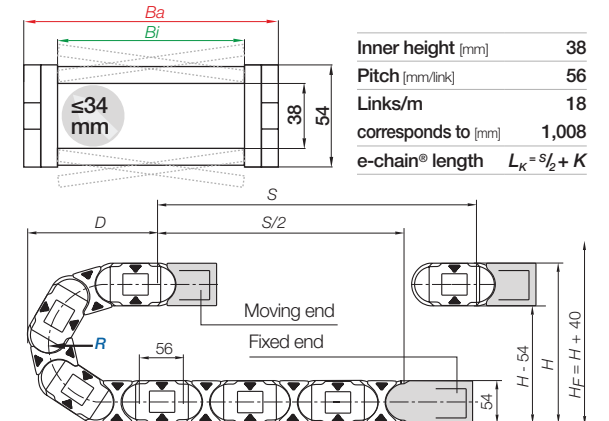
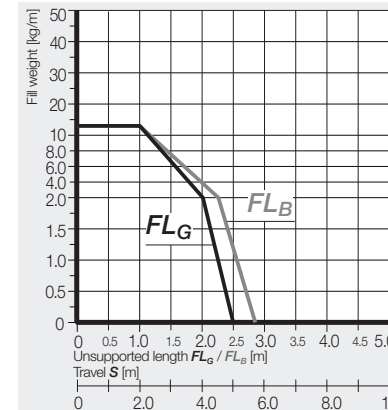

	063 ¹⁾	075 ¹⁾	100 ¹⁾	125	150	175	200	250	300	350*
R	063 ¹⁾	075 ¹⁾	100 ¹⁾	125	150	175	200	250	300	350*
H	180	204	254	304	354	404	454	554	654	754
D	174	186	211	236	261	286	311	361	411	461
K	310	350	430	505	585	665	745	900	1,055	1,215

The required clearance height: $H_F = H + 40\text{mm}$ (with 2.0kg/m fill weight)

*Radius available upon request. Please consult igus® for delivery time. 1) Radius not available for e-tubes

Gliding applications | For long travels from 10m to max. 80m

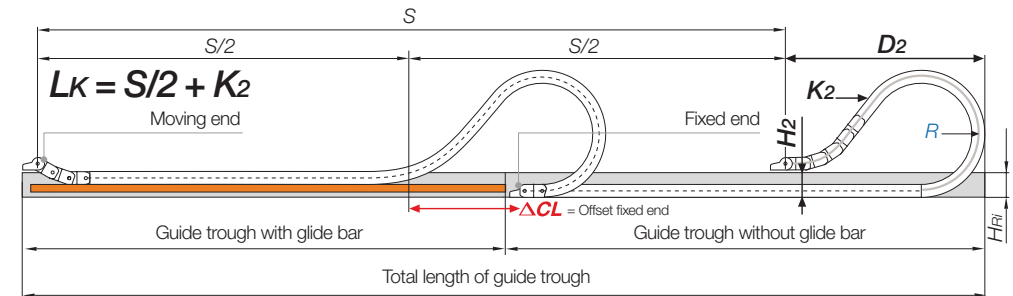

Note: We recommend the project planning of such a system to be carried out by igus®.

In case of travels between 5 and 10m we recommend an e-chain® with a longer unsupported length.

	063 ¹⁾	075 ¹⁾	100 ¹⁾	125	150	175	200	250 ²⁾	300 ²⁾	350 ²⁾
R	063 ¹⁾	075 ¹⁾	100 ¹⁾	125	150	175	200	250 ²⁾	300 ²⁾	350 ²⁾
H ₂	180	204	96	96	96	96	96	-	-	-
D ₂	174	186	370	470	500	655	770	-	-	-
K ₂	310	350	616	784	896	1,120	1,288	-	-	-
ΔCL	-	-	160	210	240	370	460	-	-	-

1) Radius not available for e-tubes 2) Radius not suitable for long travels. Please consult igus®.

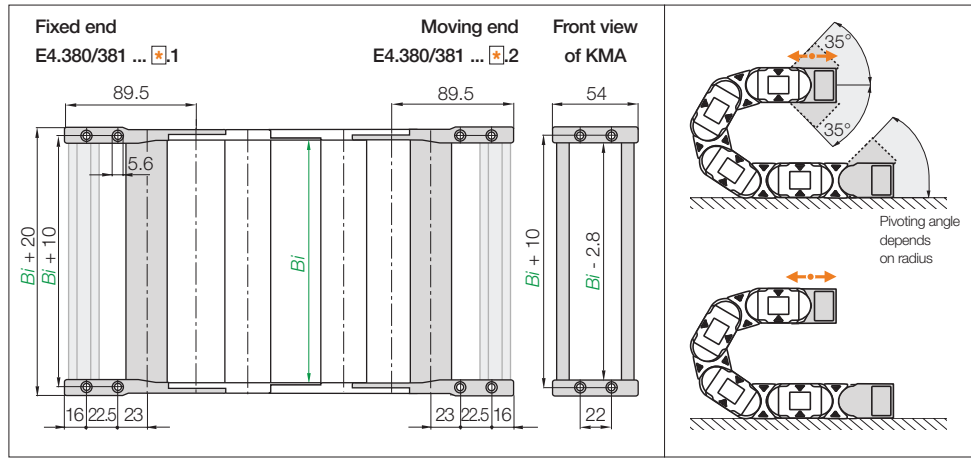

KMA pivoting | Recommended for unsupported and gliding applications
KMA locking | Recommended for vertical hanging and standing applications

Width index	Part No. full set KMA pivoting	Part No. full set KMA locking	Bi [mm]	Width index	Part No. full set KMA pivoting	Part No. full set KMA locking	Bi [mm]
050.	E4.380.050.12.C	E4.381.050.12.C	050	225.	E4.380.225.12.C	E4.381.225.12.C	225
062.	E4.380.062.12.C	E4.381.062.12.C	062	237.	E4.380.237.12.C	E4.381.237.12.C	237
075.	E4.380.075.12.C	E4.381.075.12.C	075	250.	E4.380.250.12.C	E4.381.250.12.C	250
087.	E4.380.087.12.C	E4.381.087.12.C	087	262.	E4.380.262.12.C	E4.381.262.12.C	262
100.	E4.380.100.12.C	E4.381.100.12.C	100	275.	E4.380.275.12.C*	E4.381.275.12.C*	275
105.	E4.380.105.12.C	E4.381.105.12.C	105	287.	E4.380.287.12.C*	E4.381.287.12.C*	287
112.	E4.380.112.12.C	E4.381.112.12.C	112	300.	E4.380.300.12.C	E4.381.300.12.C	300
125.	E4.380.125.12.C	E4.381.125.12.C	125	312.	E4.380.312.12.C*	E4.381.312.12.C*	312
137.	E4.380.137.12.C	E4.381.137.12.C	137	325.	E4.380.325.12.C*	E4.381.325.12.C*	325
150.	E4.380.150.12.C	E4.381.150.12.C	150	337.	E4.380.337.12.C*	E4.381.337.12.C*	337
162.	E4.380.162.12.C	E4.381.162.12.C	162	350.	E4.380.350.12.C*	E4.381.350.12.C*	350
175.	E4.380.175.12.C	E4.381.175.12.C	175	362.	E4.380.362.12.C*	E4.381.362.12.C*	362
187.	E4.380.187.12.C*	E4.381.187.12.C*	187	375.	E4.380.375.12.C*	E4.381.375.12.C*	375
200.	E4.380.200.12.C	E4.381.200.12.C	200	387.	E4.380.387.12.C*	E4.381.387.12.C*	387
212.	E4.380.212.12.C*	E4.381.212.12.C*	212	400.	E4.380.400.12.C*	E4.381.400.12.C*	400

(KMA = polymer metal mounting bracket) For the C-profile option please add index .C

*Width available upon request. Please consult igus® for delivery time.

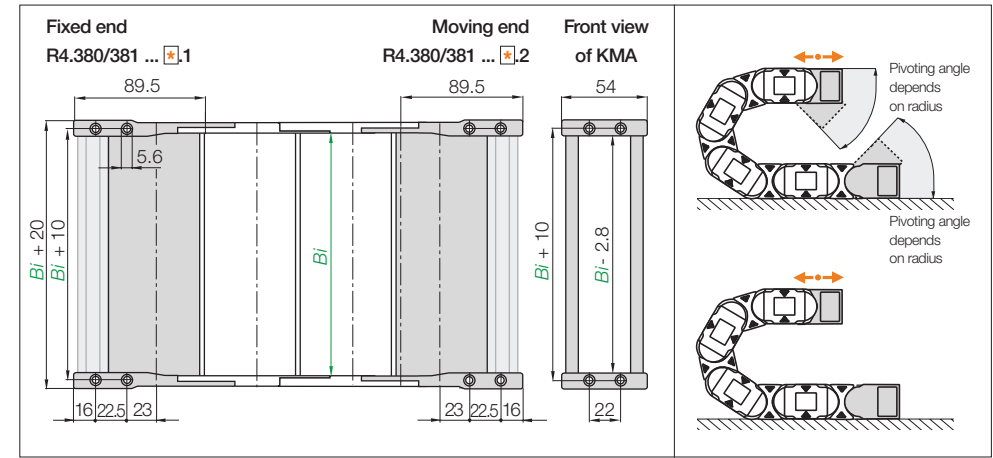

KMA pivoting | Recommended for unsupported and gliding applications
KMA locking | Recommended for vertical hanging and standing applications

Width index	Part No. full set KMA pivoting	Part No. full set KMA locking	Bi [mm]	Width index	Part No. full set KMA pivoting	Part No. full set KMA locking	Bi [mm]
050.	R4.380.050.12.C	R4.381.050.12.C	050	175.	R4.380.175.12.C	R4.381.175.12.C	175
075.	R4.380.075.12.C	R4.381.075.12.C	075	200.	R4.380.200.12.C	R4.381.200.12.C	200
100.	R4.380.100.12.C	R4.381.100.12.C	100	250.	R4.380.250.12.C	R4.381.250.12.C	250
125.	R4.380.125.12.C	R4.381.125.12.C	125	300.	R4.380.300.12.C*	R4.381.300.12.C*	300
150.	R4.380.150.12.C	R4.381.150.12.C	150				

(KMA = polymer metal mounting bracket) For the C-profile option please add index .C

*Width available upon request. Please consult igus® for delivery time.

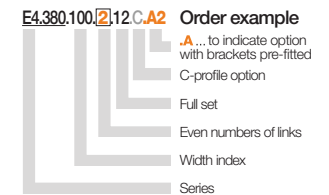
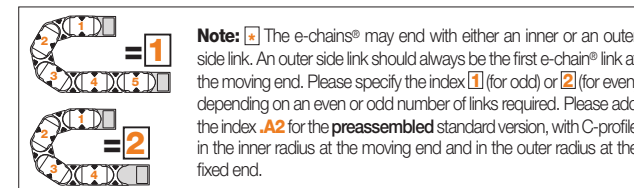

Strain relief e.g. clamps, tiewrap plates, nuggets and plug-in clips are available from stock. The complete chainfix range with ordering options ▶ From page 1300

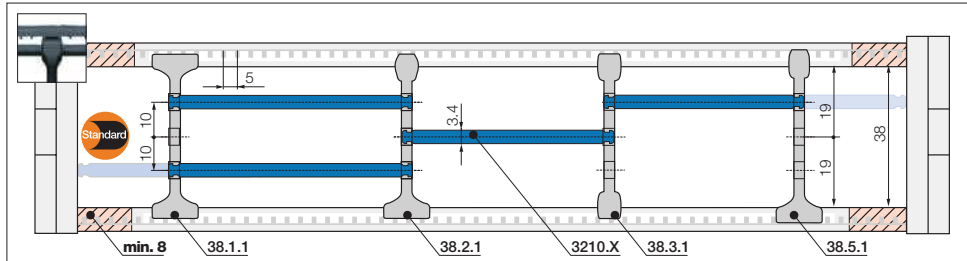

Note: Please be aware of the minimum lateral gap to the side links! **e-tube: 8mm** | **e-chain®: 8mm**
As standard separators are fitted every 2nd e-chain® link!

Standard separator, wide base

unassembled **38.1**
assembled **38.1.1**

Standard - for any application
Separator with a wide base for maximum holding force in the e-chain®.

Separator, narrow top

unassembled **38.2**
assembled **38.2.1**

For even faster installation
Wide on one side for high holding force, narrow on opposite side for easy cable fitting.

Separator, narrow

unassembled **38.3**
assembled **38.3.1**

For small cables
Separator with a narrow base for a large number of small cables side by side. Saves space in the e-chain®.

Notch separator for notched crossbar

unassembled **38.5**
assembled **38.5.1**

Locks securely in preset increments
Notch separator for exact positioning in e-chains®. Recommended for side-mounted applications.

Shelf, lockable

unassembled **3200.X**
assembled **3210.X**

Horizontal separation
Full-width shelf locks securely into separators at both ends, giving a fixed width. Can be used as full-width or partial shelf.

Shelves Width = X (mm)	X (mm)		X (mm)		X (mm)			
	unassembled	assembled	unassembled	assembled	unassembled	assembled		
050	3200.050	3210.050	125	3200.125	3210.125	225	3200.225	3210.225
075	3200.075	3210.075	150	3200.150	3210.150	250	3200.250	3210.250
100	3200.100	3210.100	175	3200.175	3210.175			
115	3200.115	3210.115	200	3200.200	3210.200			

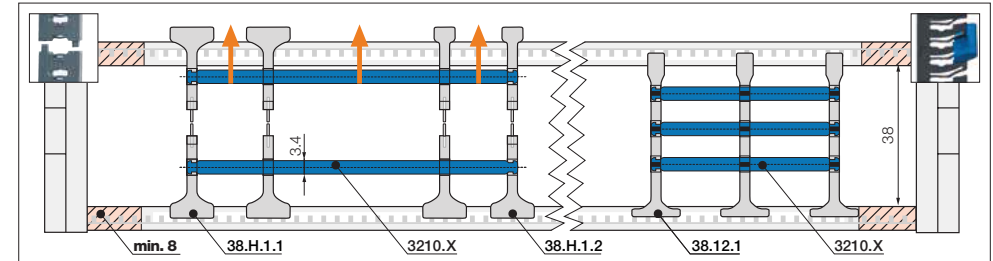

Note: Please be aware of the minimum lateral gap to the side links! **e-tube: 8mm** | **e-chain®: 8mm**
As standard separators are fitted every 2nd e-chain® link!

Split separator, wide base/top

unassembled **38.H.1**
assembled **38.H.1.1**

Split separators
In order to fill e-chains® more easily and effectively, these separators can be split in the middle. This allows easier access to middle shelf partitions. Fast assembly and easy retrofit. 2 types available: with wide or narrow top.

Split separator, narrow top

unassembled **38.H.2**
assembled **38.H.2.1**

Lean separator

unassembled **38.12**
assembled **38.12.1**

Lean separators
New design allows extremely fast fitting of shelves in several layers, which significantly reduces assembly time. Enables extremely fast replacement of individual cables in a very full e-chain®.

Lean separator design - several layers of cables fitted quickly, save up to 50%* assembly time
(*Lean separator vs. standard separator - measured on a 4m long e-chain® fitted with 12 cables in the igus® harnessing factory)



e-chain® with openable extender crossbars

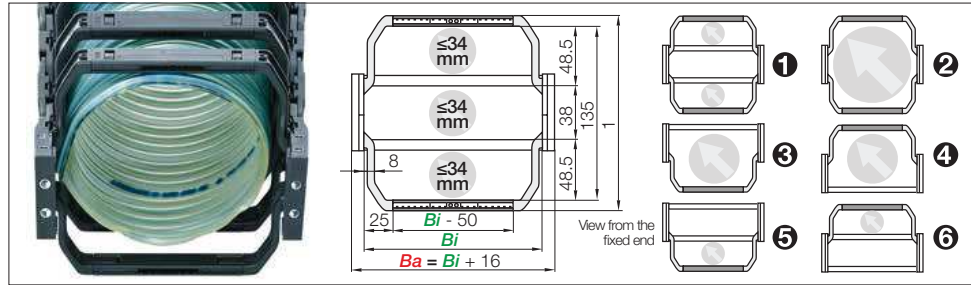

Extender crossbars with flexible width | Safe guiding for large hoses

- For guiding and protecting large hoses
- With mounting for noise dampers
- Cable-friendly design, high crossbar holding force
- The openable extender crossbars can be fitted in different ways and combinations
- Optionally openable along the inner or outer radius

Versions e-chain® with extender crossbar	Hose Ø ≤ [mm]	Part No. e-chain® with extender crossbar
① Extender crossbar and standard crossbar alternating along the inner and outer radius ¹⁾	34	E4.38L.XXXHB48.R.0
② Extender crossbar on both sides along the inner and outer radius ²⁾	122	E4.38L.XXXB48.R.0
③ Extender crossbar along the outer radius ³⁾	78	E4.38L.XXXBE48.R.0
④ Extender crossbar along the inner radius ²⁾	78	E4.38L.XXXBZ48.R.0
⑤ Extender crossbar and standard crossbar alternating along the outer radius ³⁾	34	E4.38L.XXXHBE48.R.0
⑥ Extender crossbar and standard crossbar alternating along inner radius ¹⁾	34	E4.38L.XXXHBZ48.R.0

1) Minimum bend radius: R 125 2) Minimum bend radius: R 150 3) Minimum bend radius: R 063 *Width available upon request. Delivery time upon request

Bi [mm] Available inner widths

| 100 | 112 | 125 | 137 | 150 | 162 | 175 | 187 | 200 | 212 | 225 | 237 | 250 | 262 | 275 | 287 | 300 | 312 | 325 | 337 | 350 |

Complete Part No. with the width index XXX Bi and the radius (R). Example:

E4.38L.100B48.150.0 = extender crossbar on both sides along inner and outer radius



The E4.1L can be fitted with openable extender crossbars, which increase the size of the interior of the e-chain®. Crossbars can be fitted in various ways: from one or both sides, alternating with standard crossbars and/or any combination

Aluminium support tray

- Corrosion-resistant and seawater-resistant aluminium rails with adjustable width
 - Noise-reducing glide strip integrated as standard
 - Easy installation and connection of the e-chain®
 - Open design - dirt and debris fall through
- More information ► From page 1270



TUB New

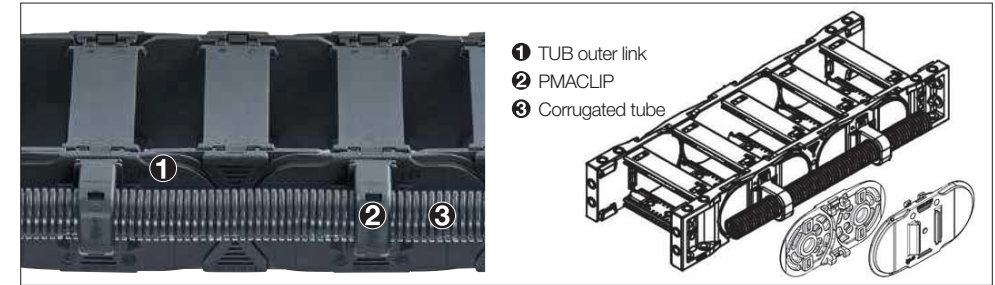

TUB | Safe guidance for corrugated tubes parallel to the e-chain®

- Additional, simple guidance for corrugated tubes on the outside of the e-chain®
- PMA CLIP allows corrugated tubes with nominal widths 07, 10, 12, 17mm to be easily clipped on
- Easy access to the corrugated tubes, fast replacement of the hoses
- Reduce assembly time and cost - easy to assemble, without any additional screws or tools
- The part number includes the e-chain® with TUB side sections; the PMA CLIP support and the hose are ordered separately

Part No. TUB Outer link right*	Part No. TUB Outer link left*	Part No. TUB Outer link at both ends*	For corrugated tube nominal diameter Ø [mm]
E4.38L.XXXTUBR.R.0	E4.38L.XXXTUBL.R.0	E4.38L.XXXTUB.R.0	07 / 10 / 12 / 17

*View from the fixed end

Part number appended with width index XXX Bi and radius (R) e.g.

E4.38L.100TUBR.150.0 = with TUB outer sections every 2nd right hand link

Product range | PMA CLIP | Support, one-piece, with safety clip

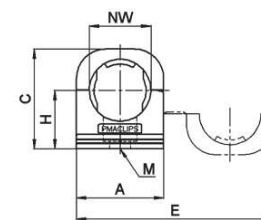

PMA CLIP support - one-piece construction with safety clip, suitable for corrugated tubes

Part No.	NW Ø [mm]	A mm	B mm	C mm	H mm	E mm	M mm
PMA CLIP							
I-BFH-07-0	07	17.0	20.0	21.5	13.5	40.5	M4
I-BFH-10-0	10	20.5	20.0	24.5	15.5	47.5	M5
I-BFH-12-0	12	24.0	20.0	27.0	16.5	54.5	M5
I-BFH-17-0	17	30.0	20.0	34.0	20.0	68.0	M6